

Серия «Рабочие тетради дошкольника»

Подготовка к письму

(часть 2)

Для
детей
5-6
лет



Солнечные
ступеньки®

Уважаемые родители и педагоги!

Перед Вами тетрадь, занимаясь по которой, дети старшего дошкольного возраста смогут подготовиться к овладению навыком письма. Задания и упражнения помогут развить мелкую моторику, зрительное восприятие и внимание.

Дети смогут выполнить штриховку фигур, обвести картинку по точкам, прописать элементы письменных букв в строчках.

В тетради Вам встретятся условные обозначения:



- раскрасить картинку;



- прописать элементы;



- выполнить штриховку.

Заниматься по тетради можно как индивидуально, так и с группой детей.

Не забудьте похвалить малышей за старание!

Желаем успеха!

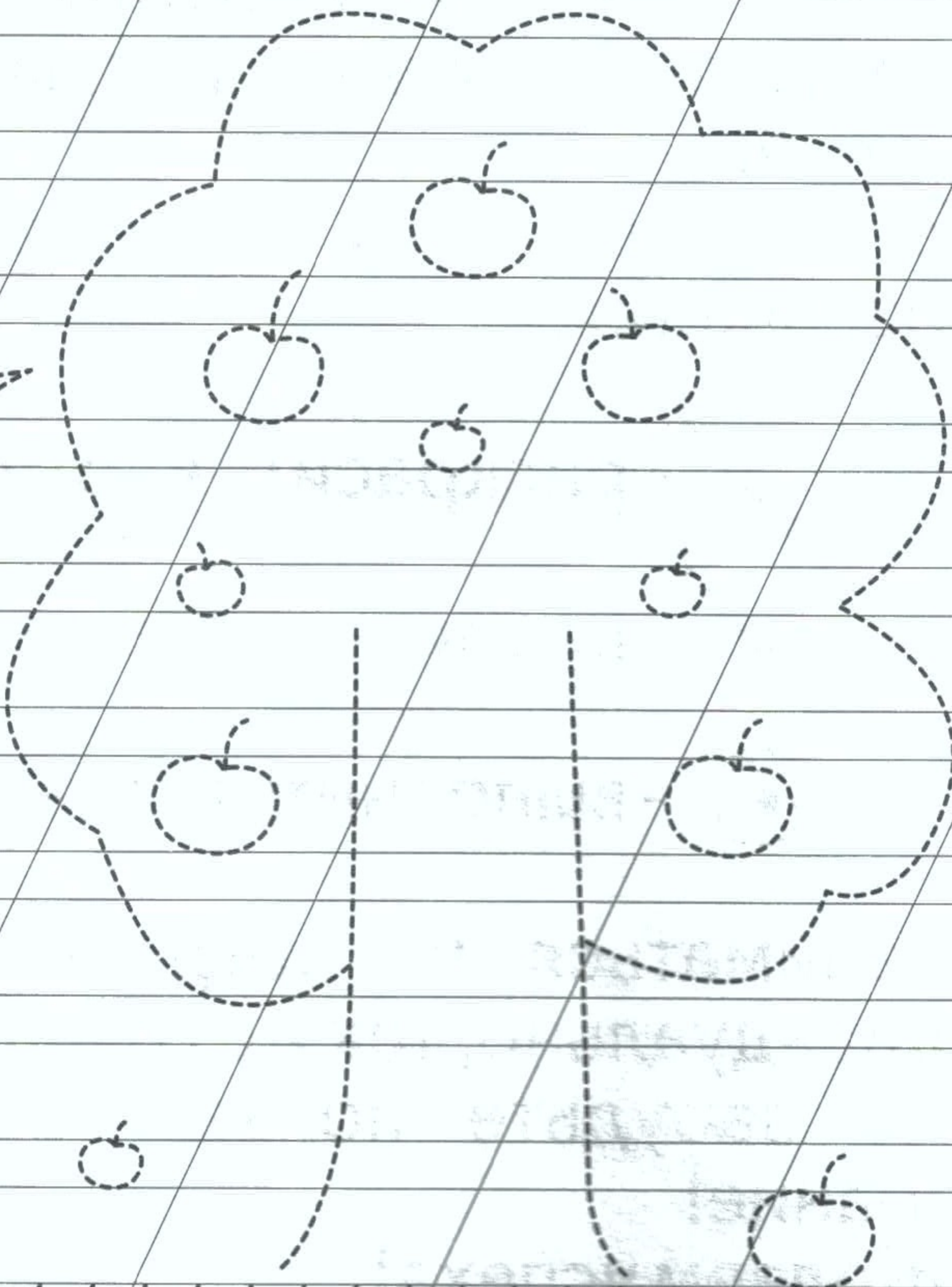
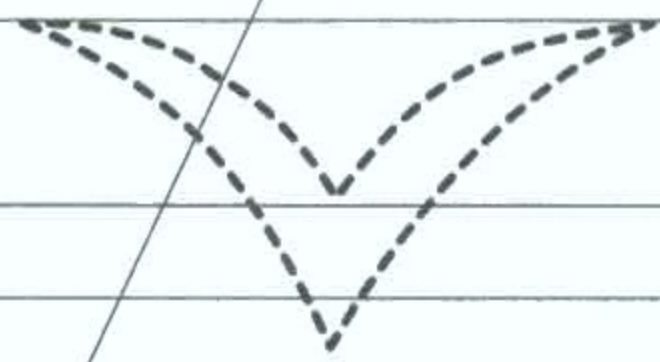
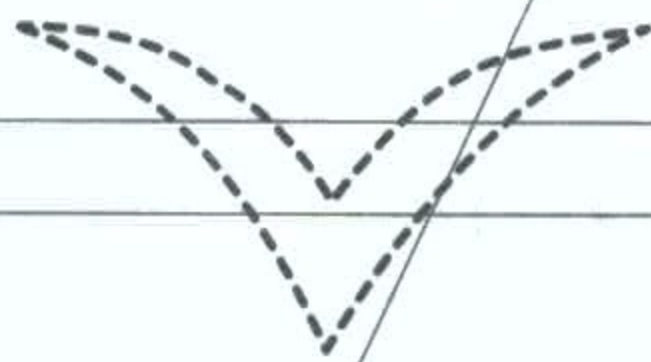
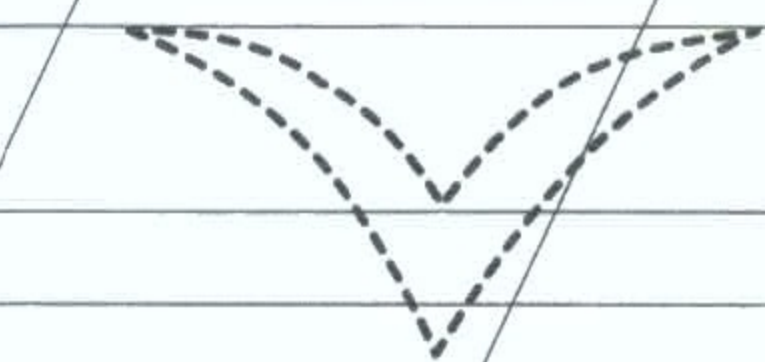
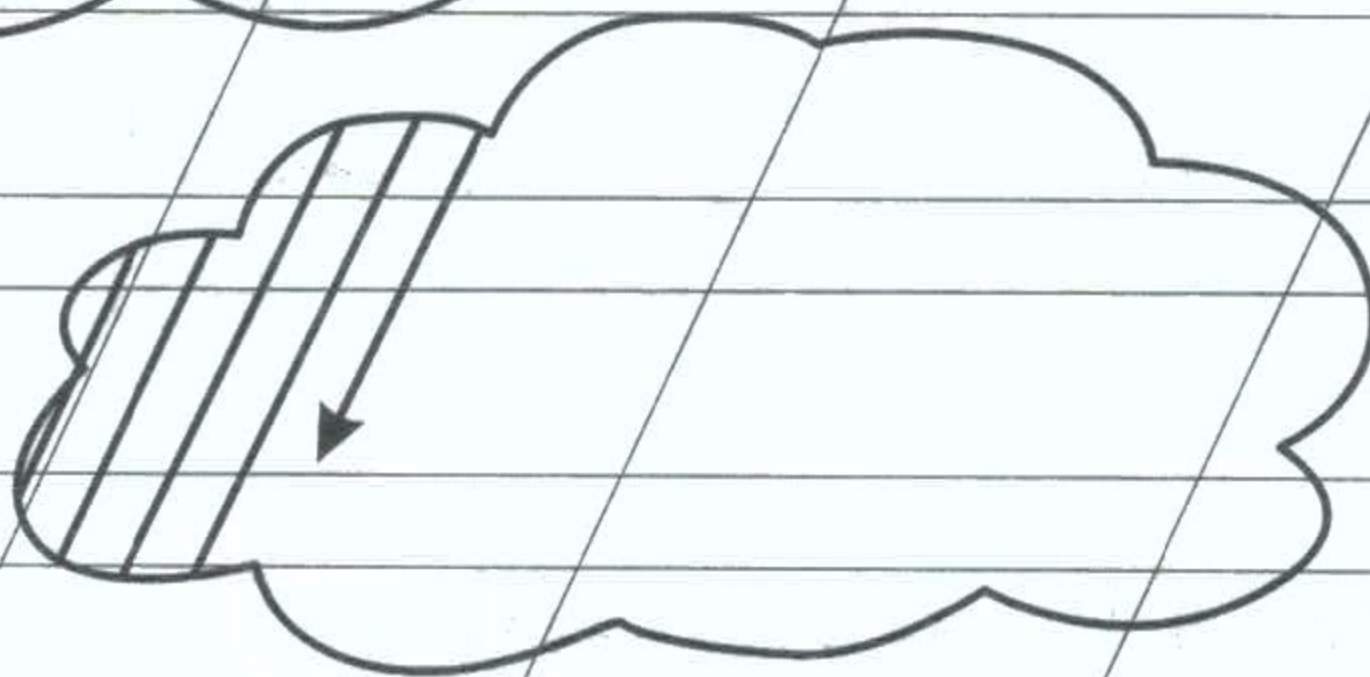
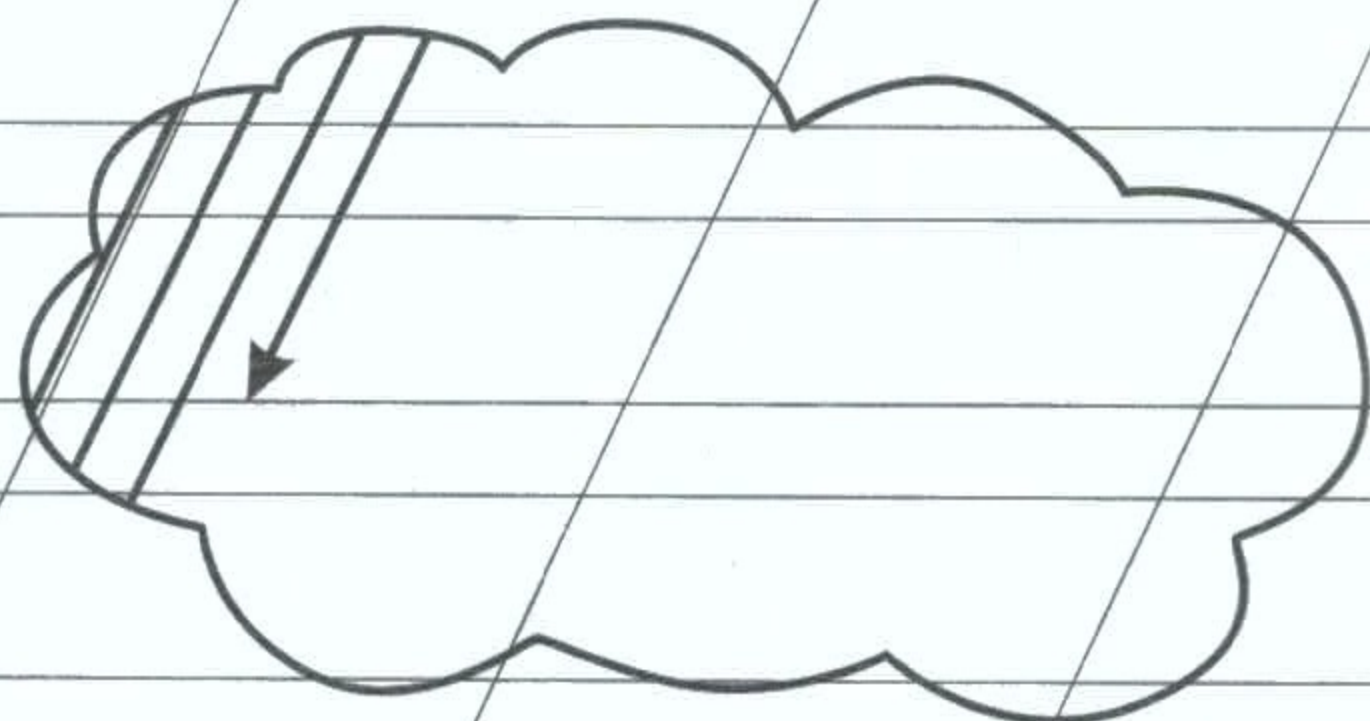
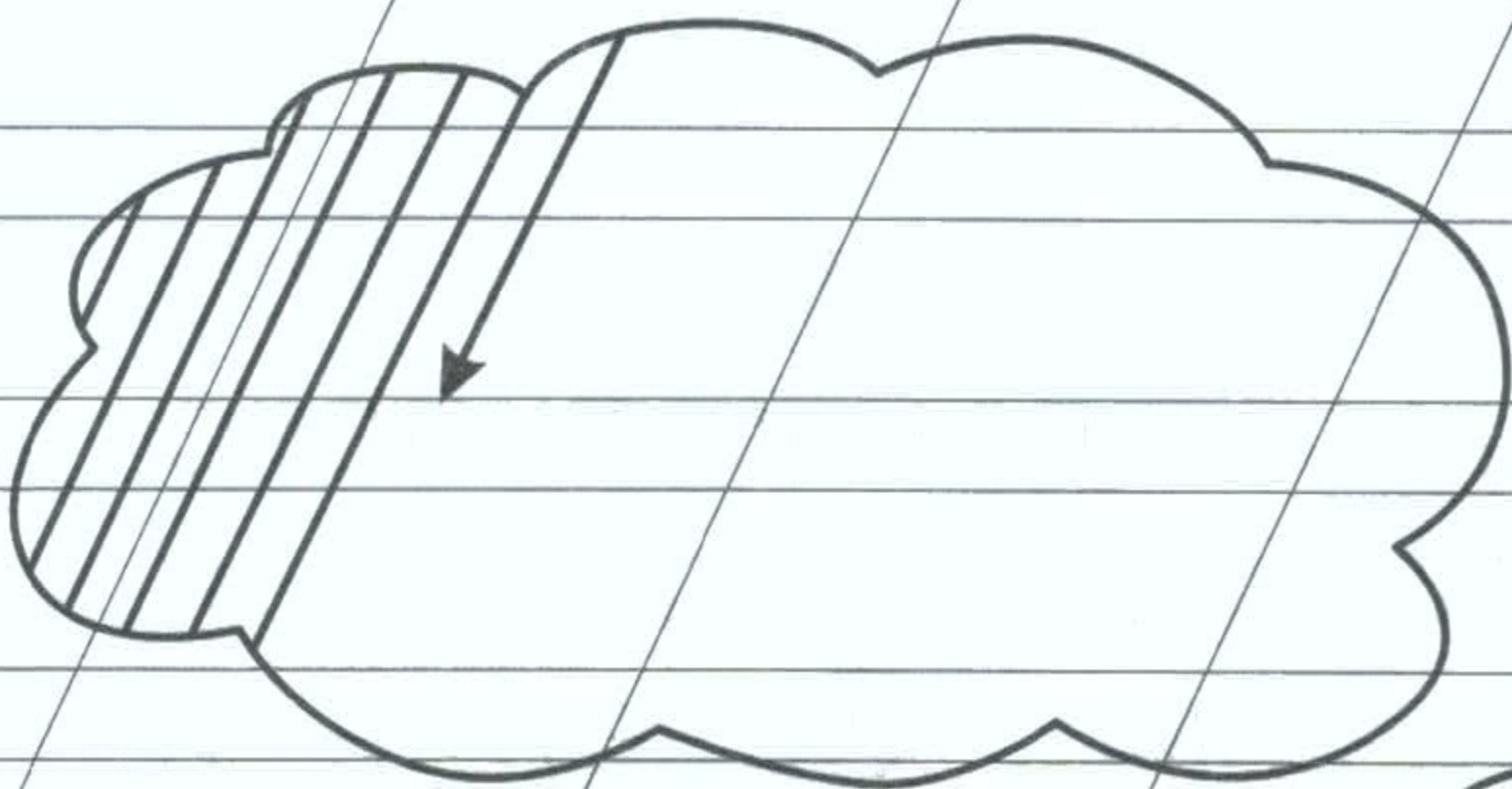

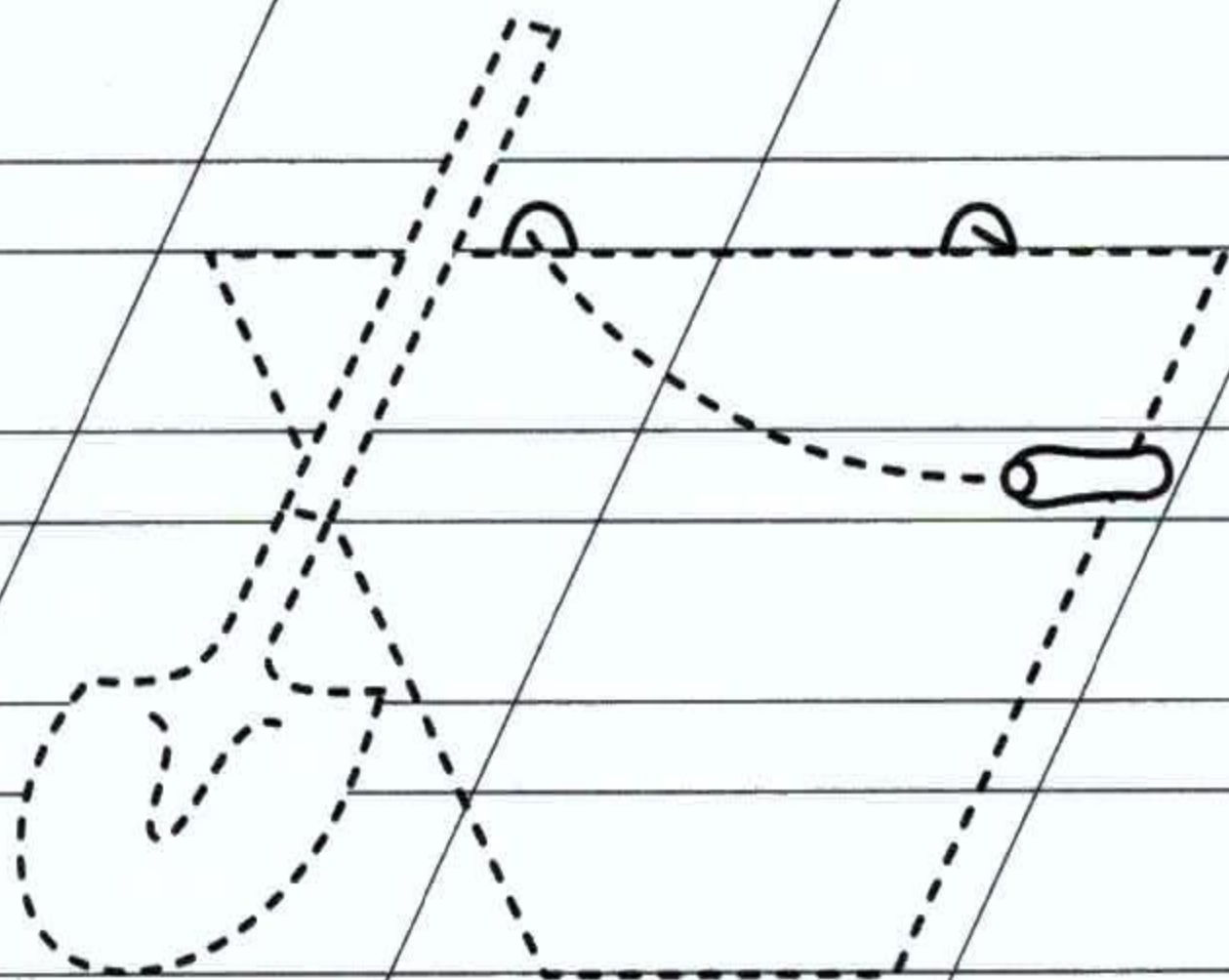
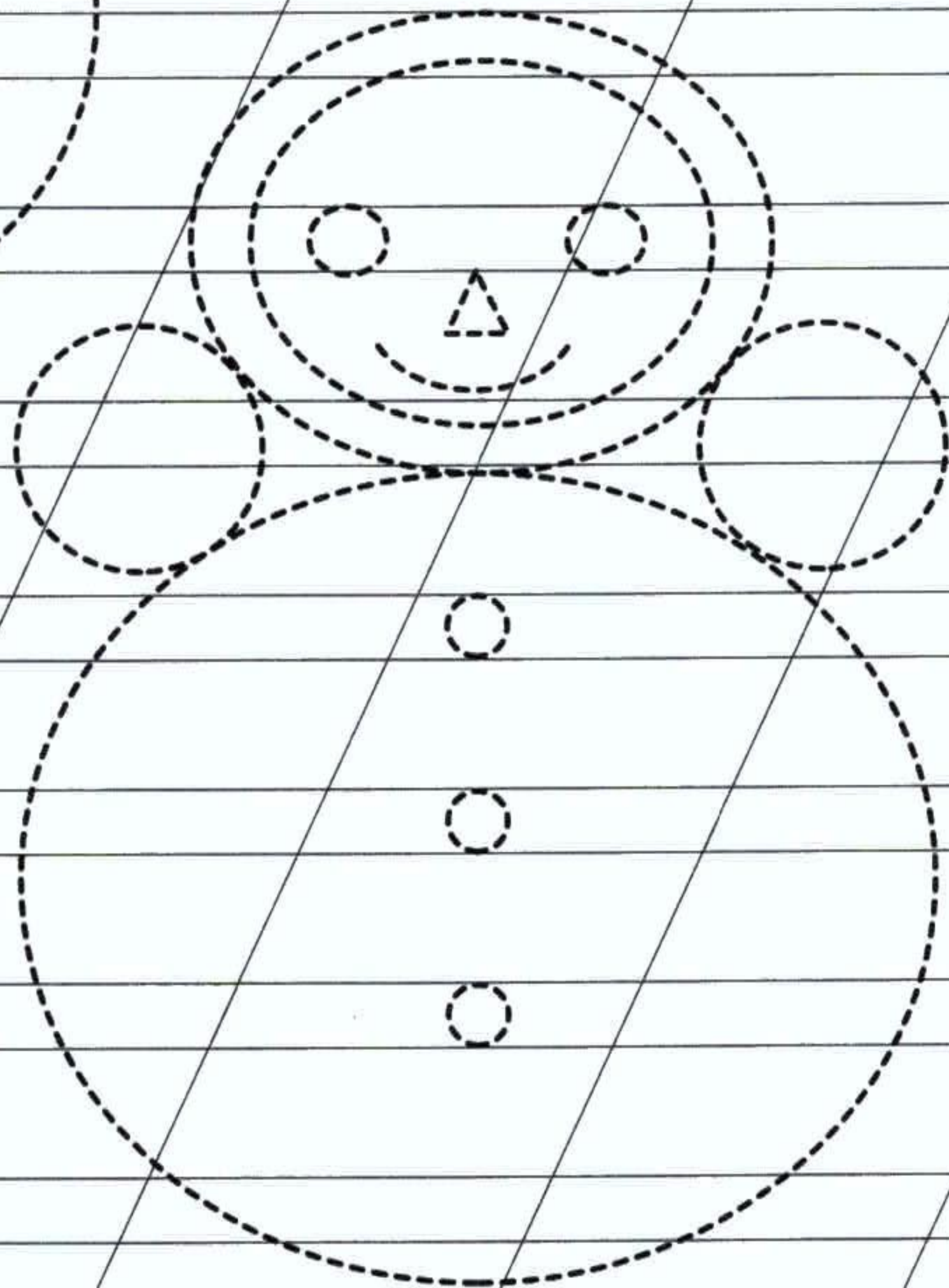
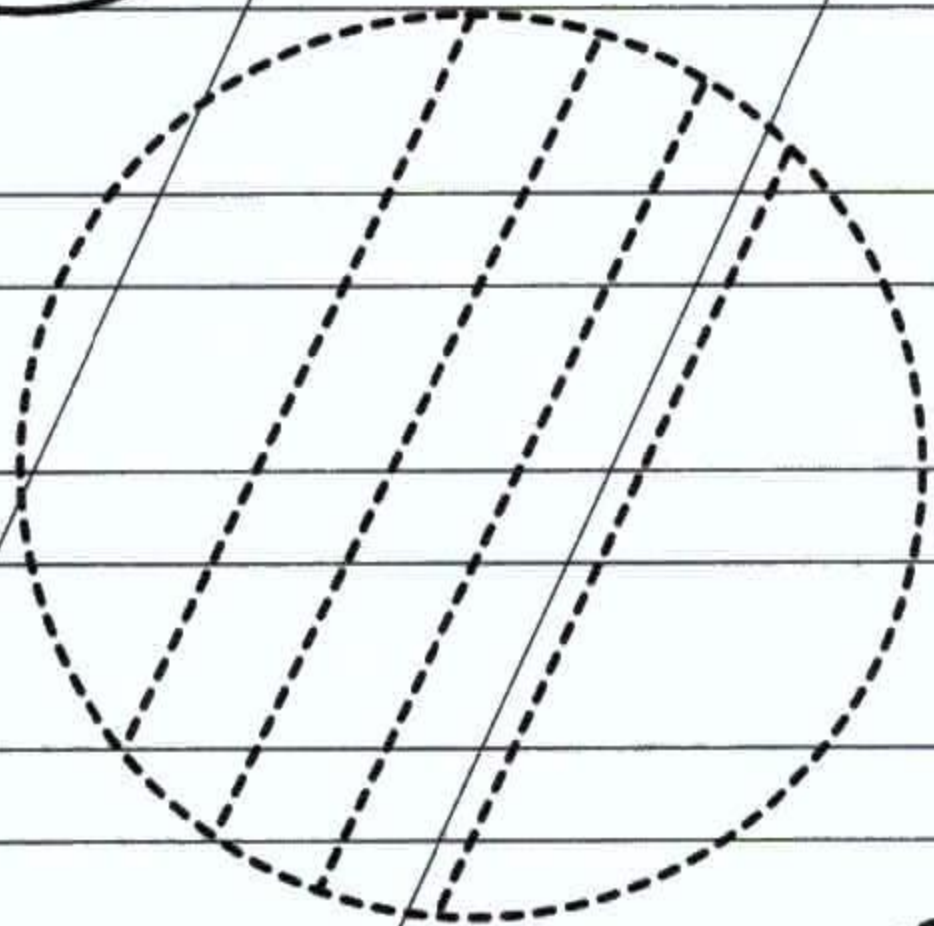
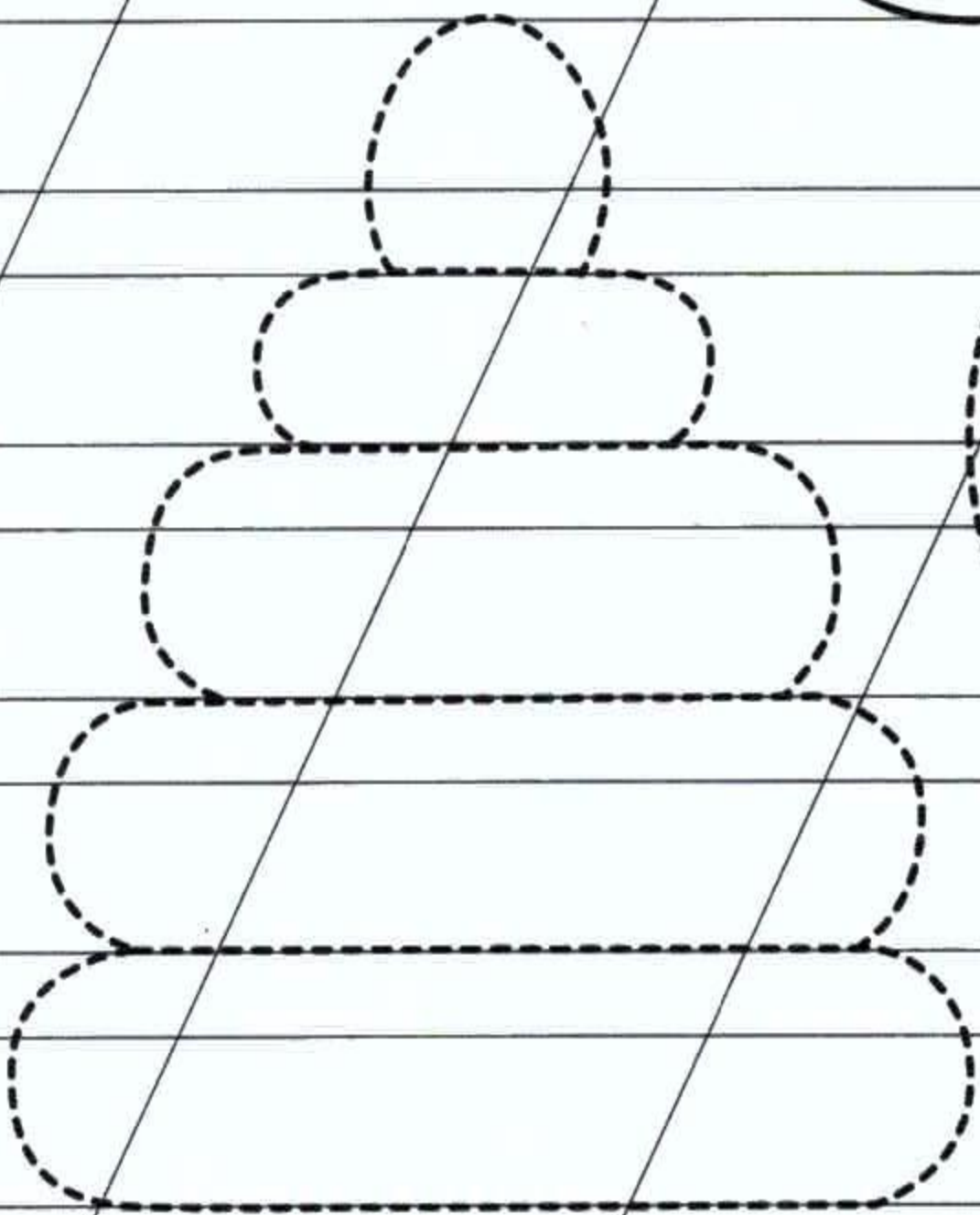
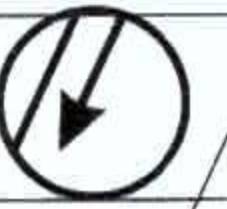
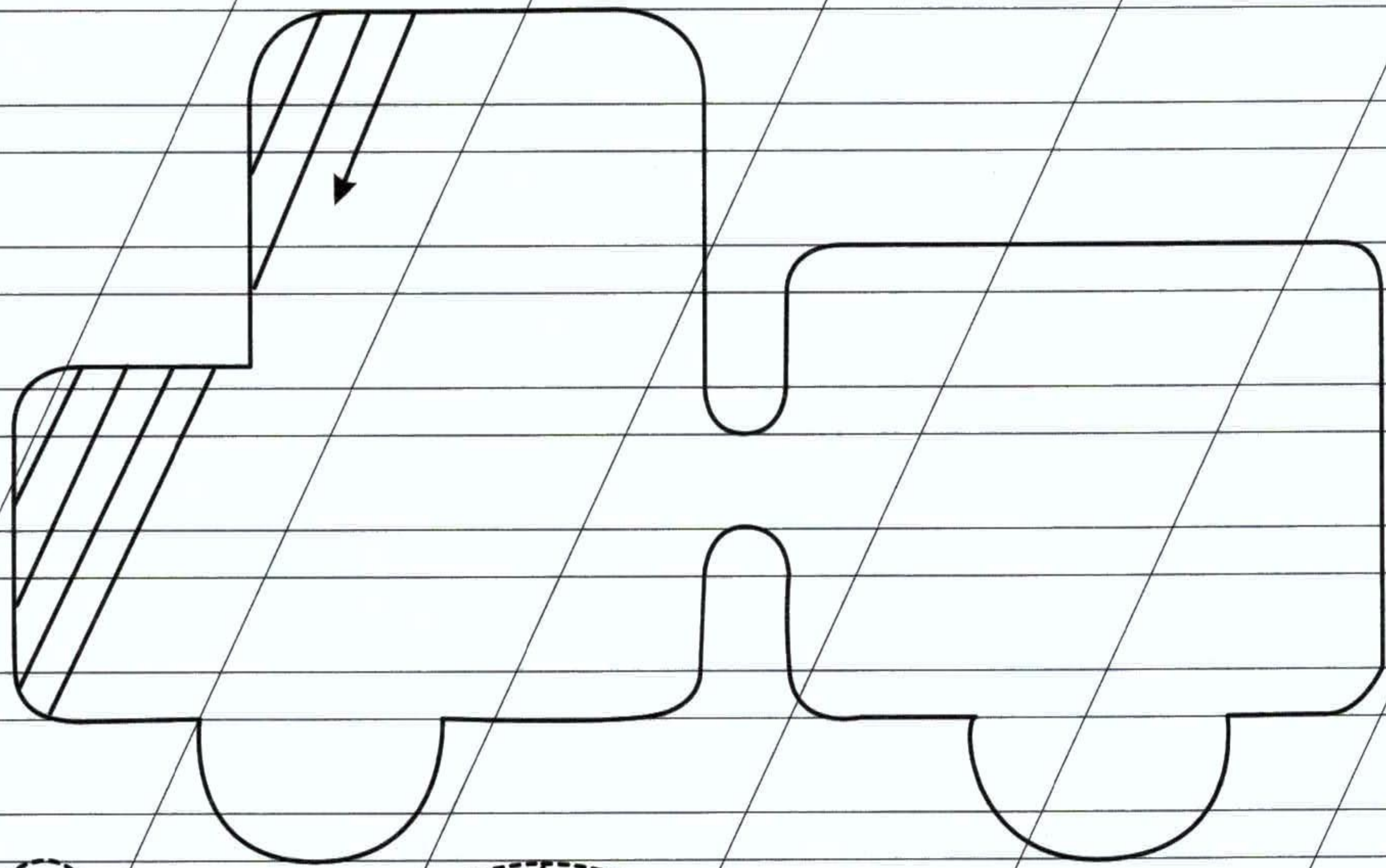

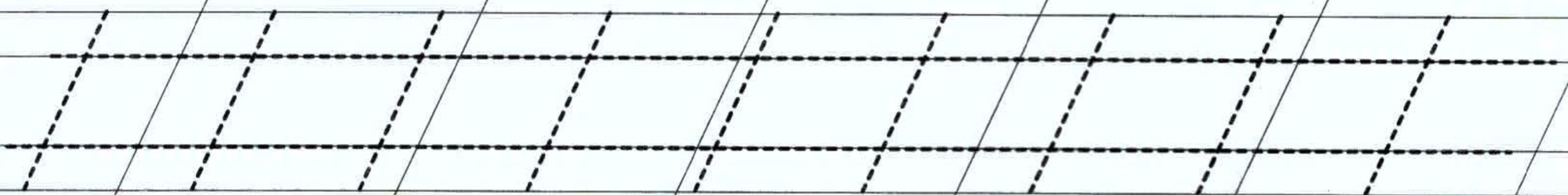
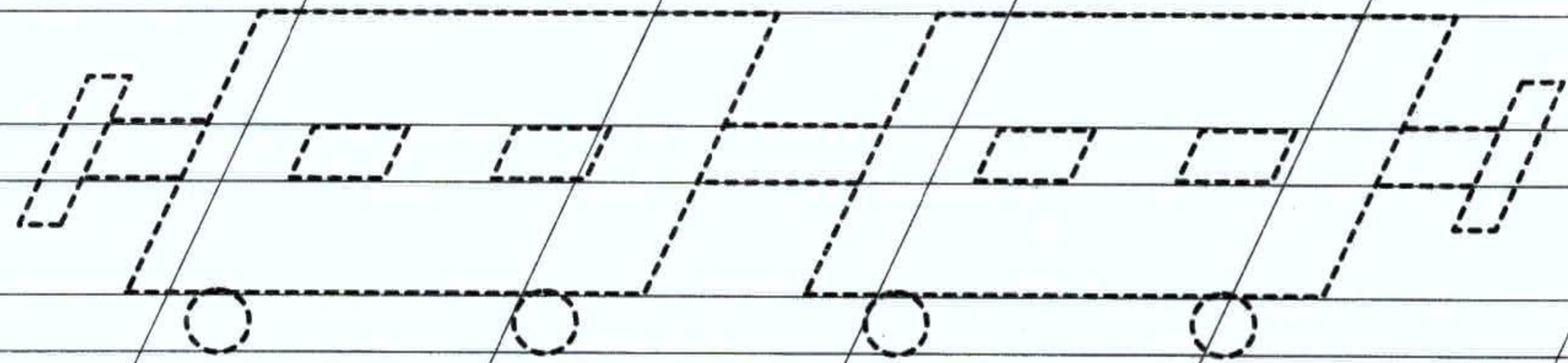
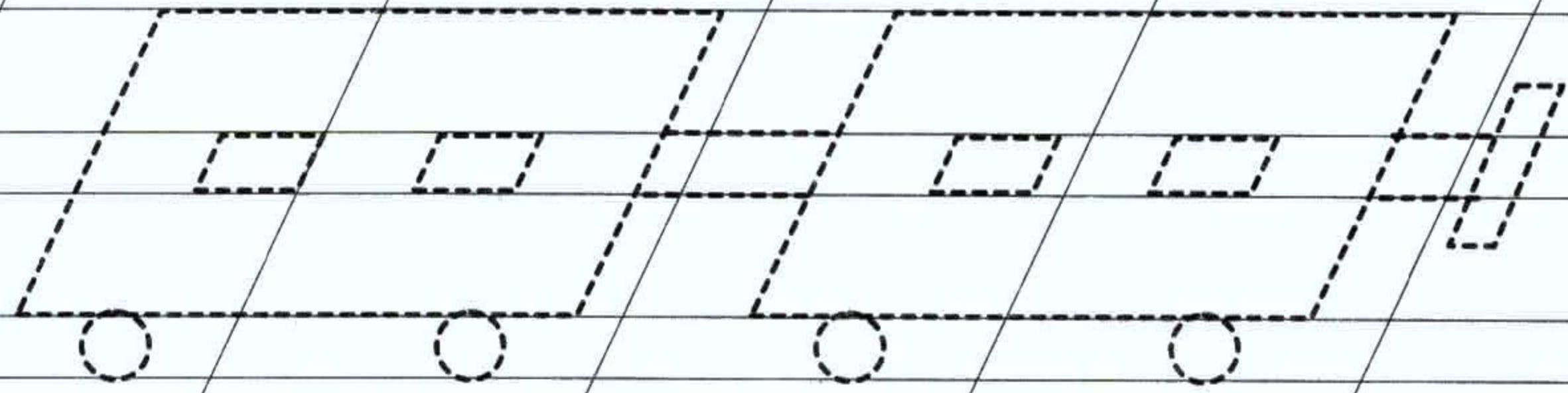
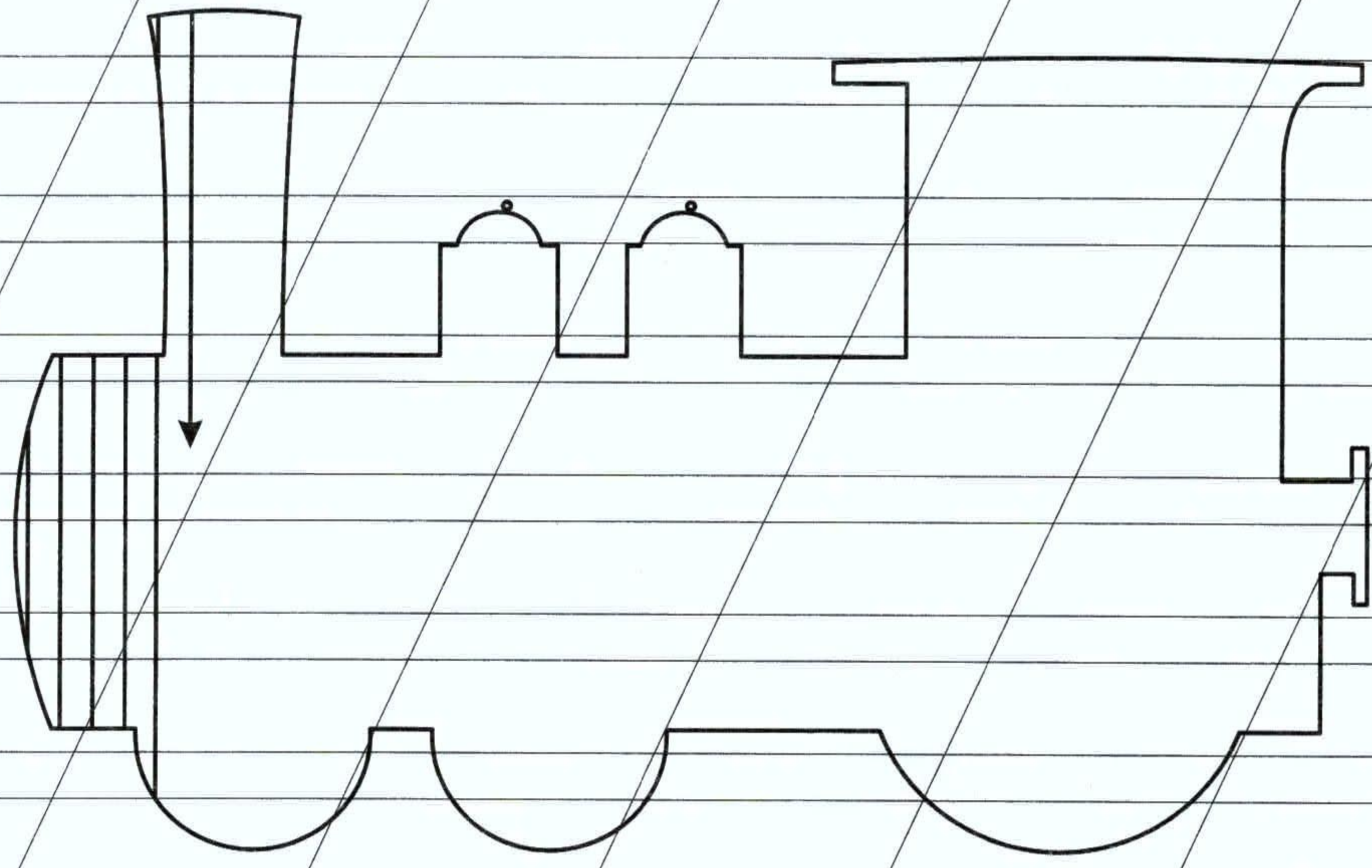

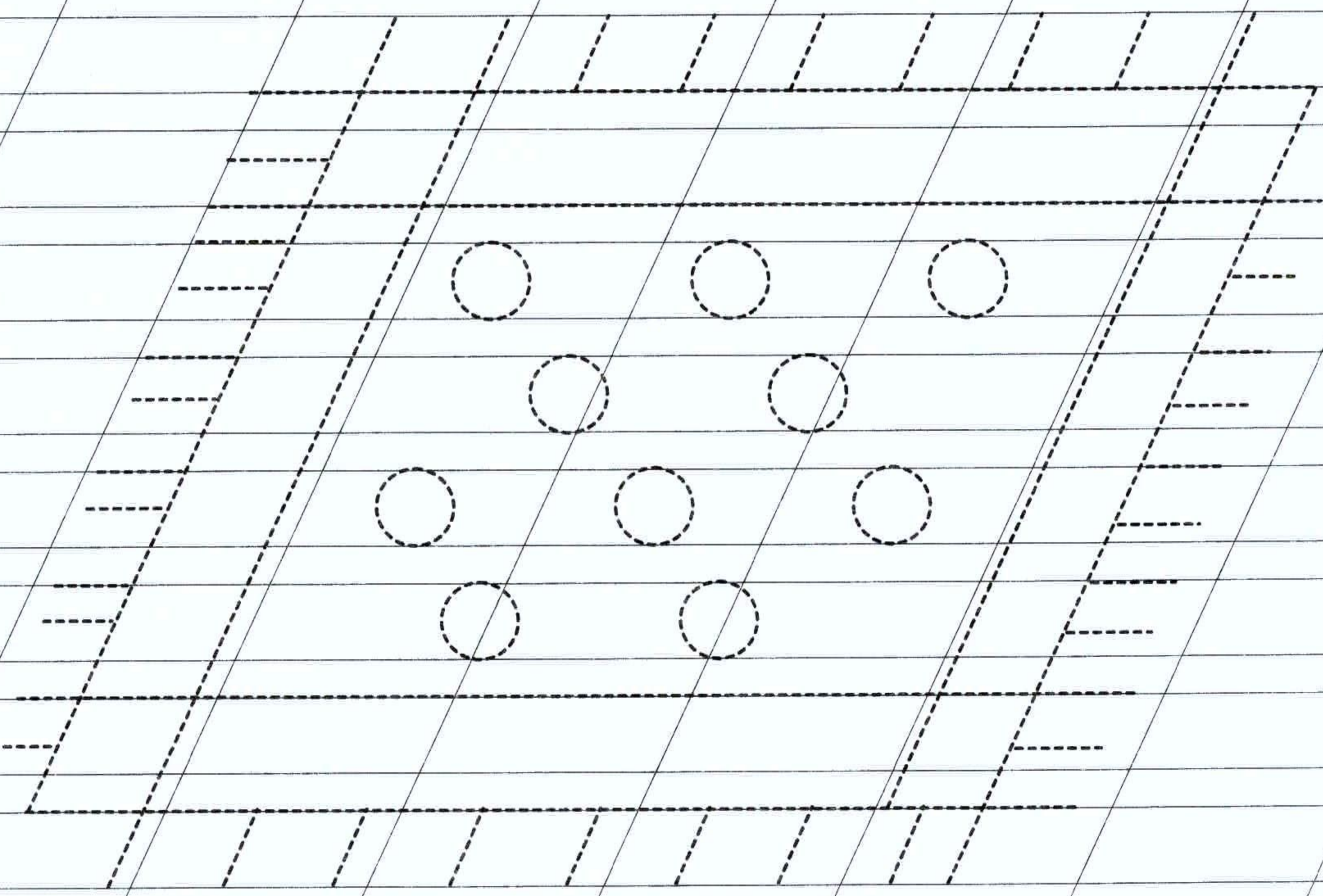
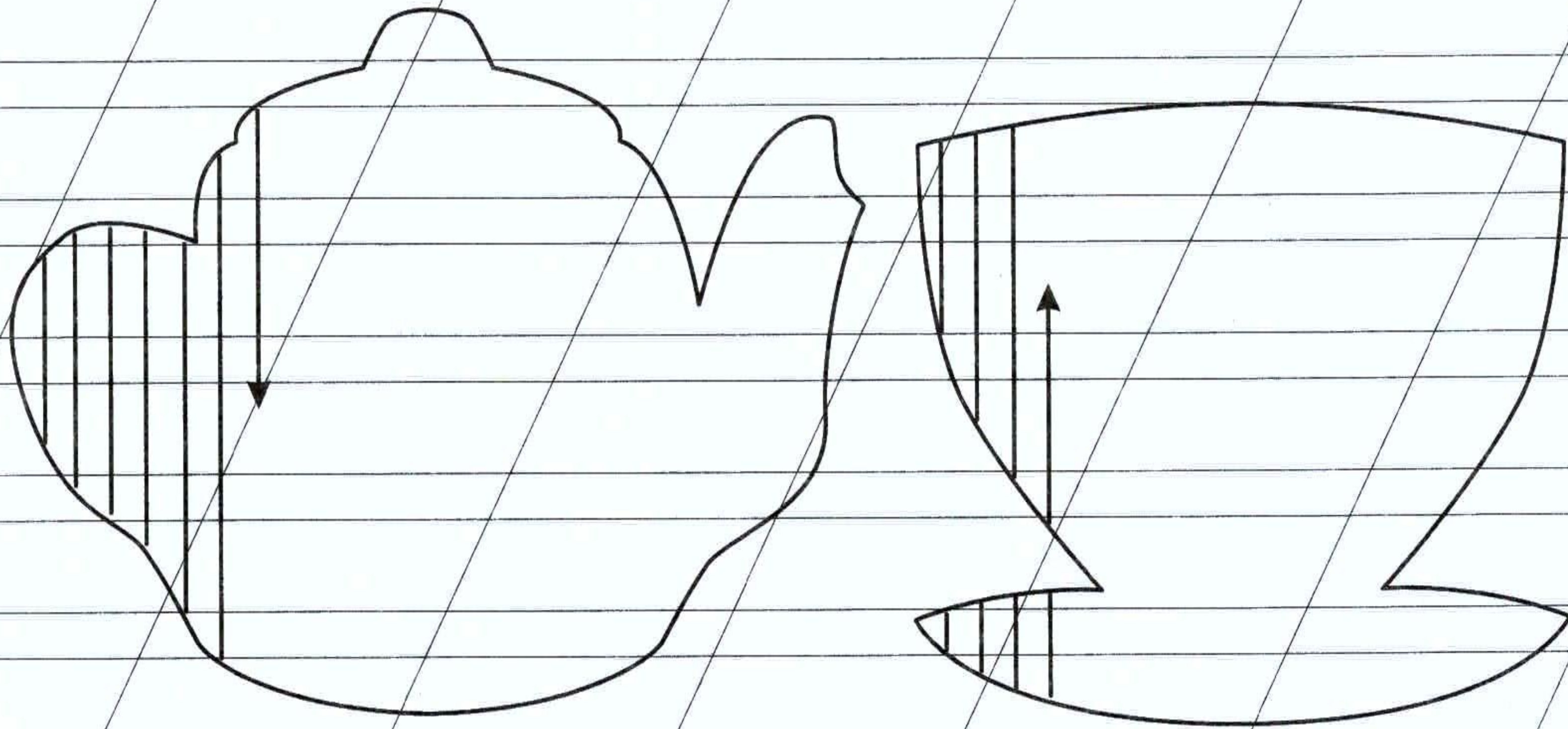

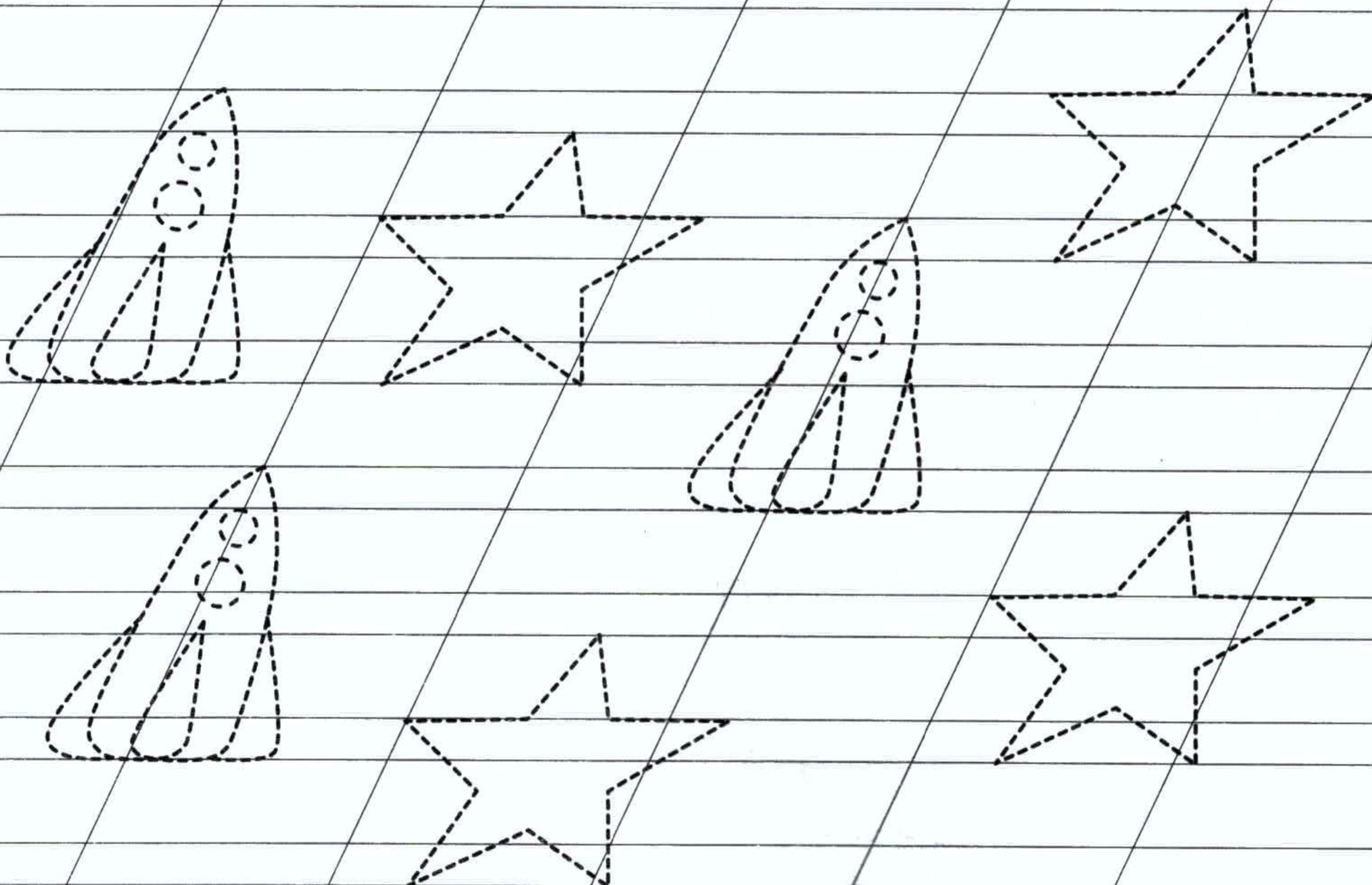
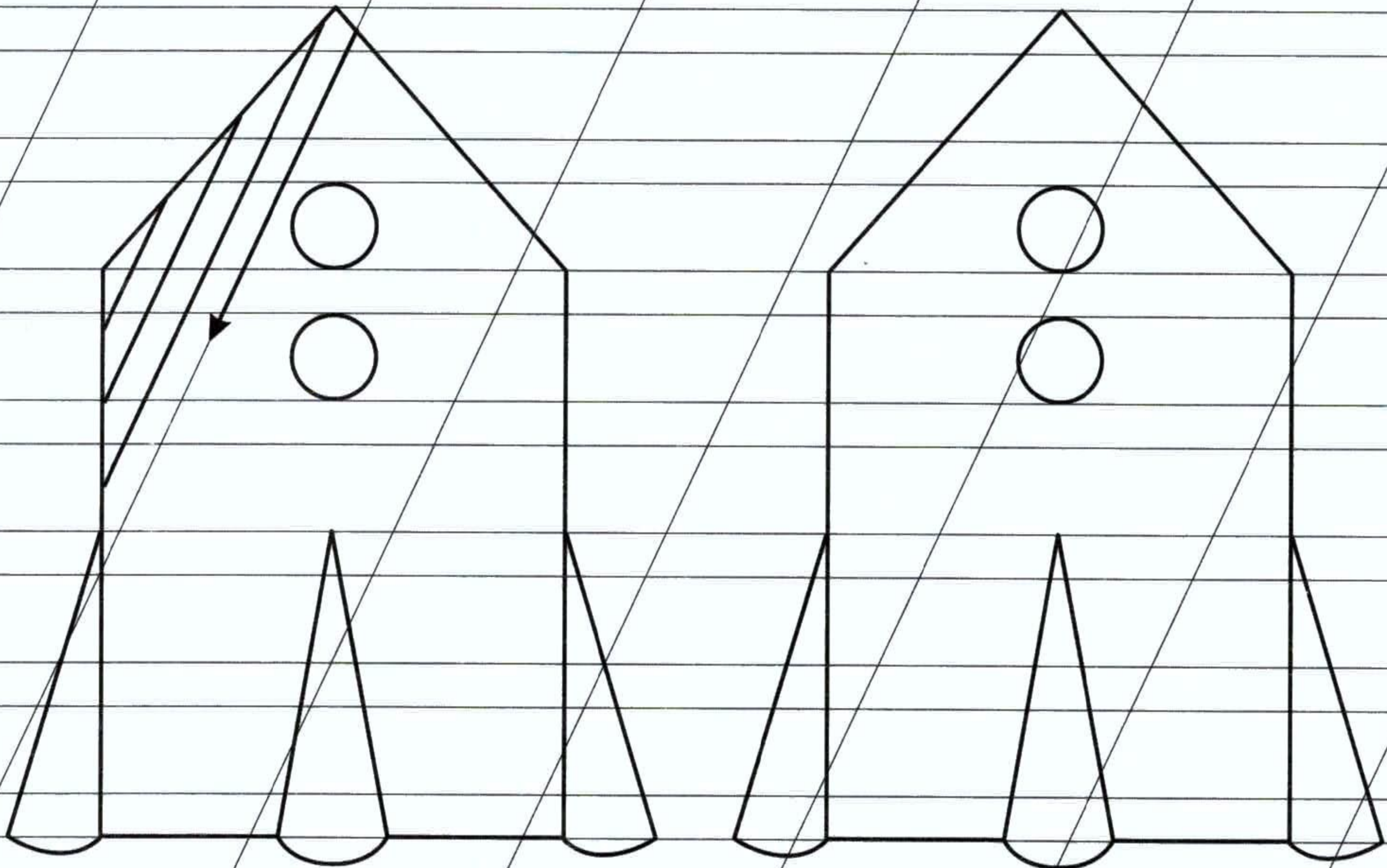

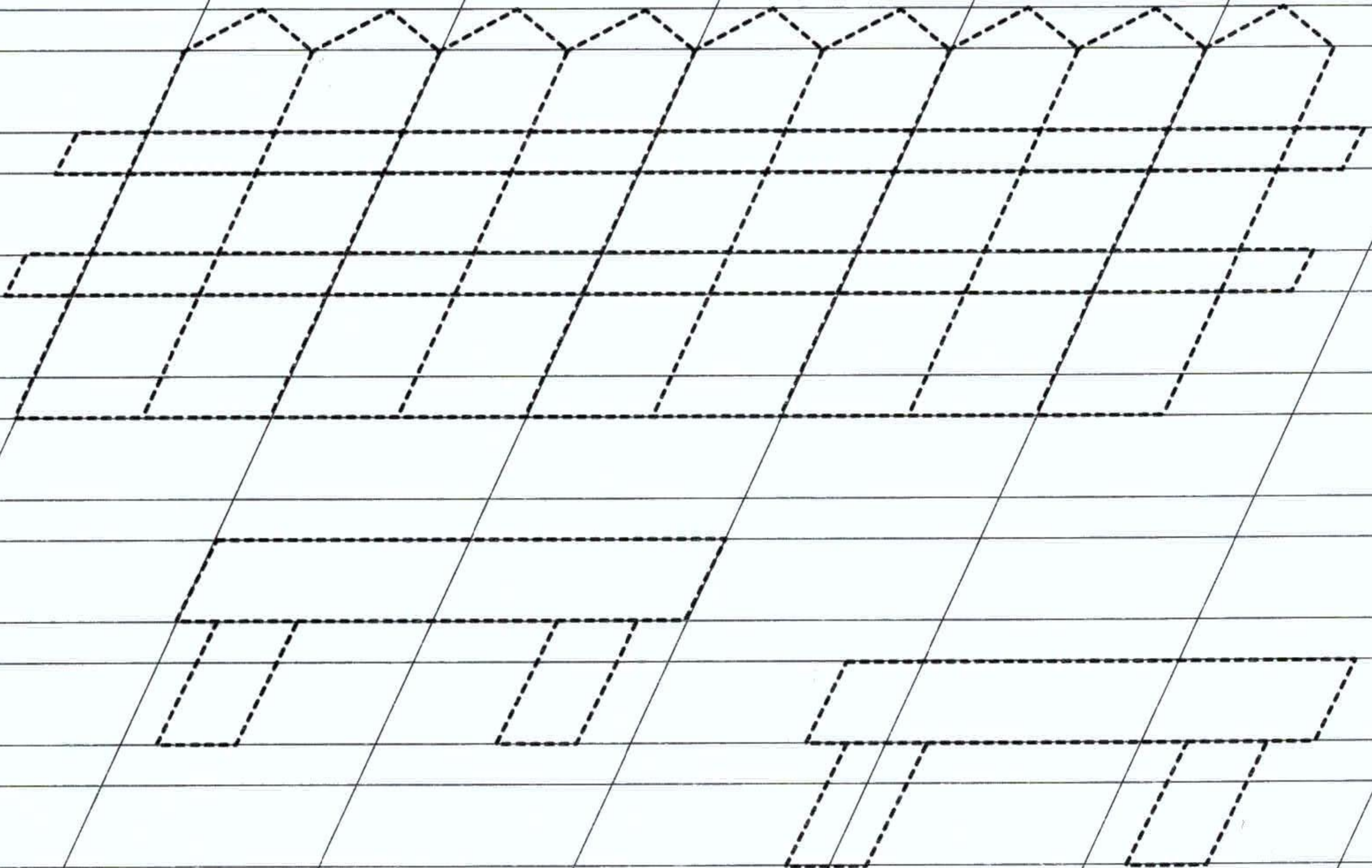
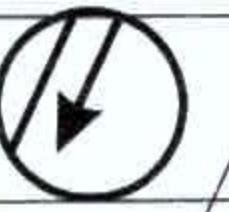
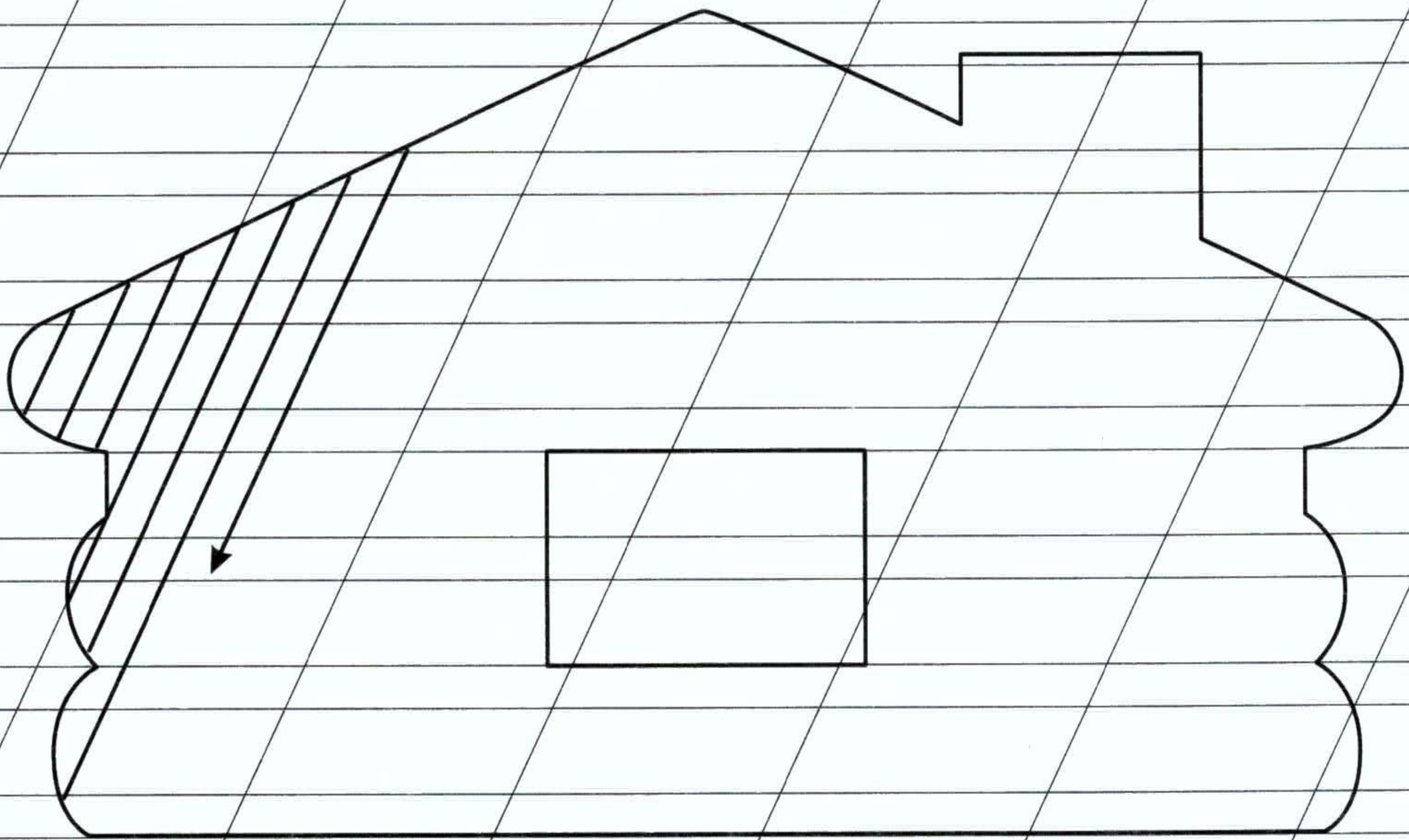

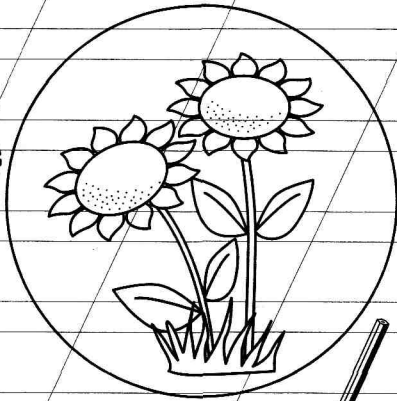
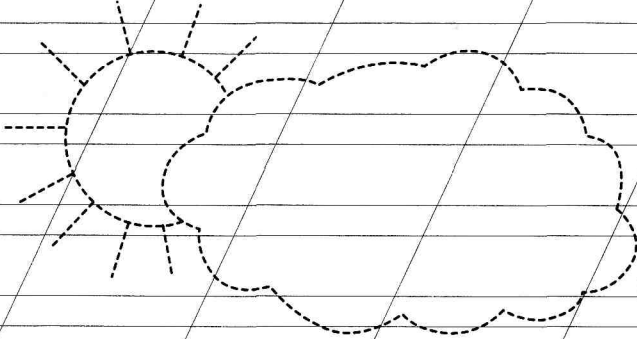
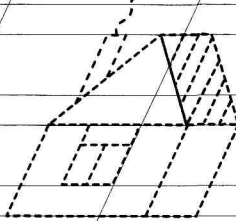
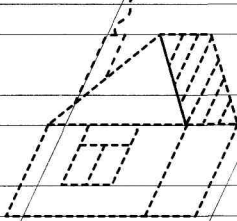
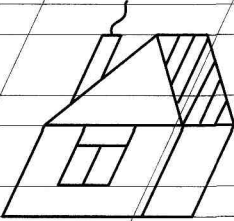
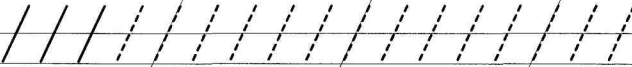
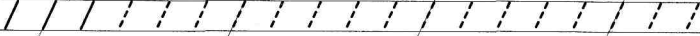

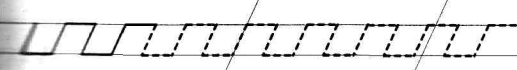
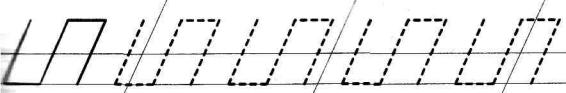
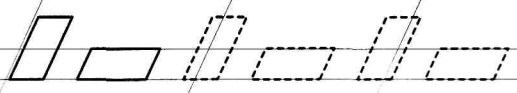
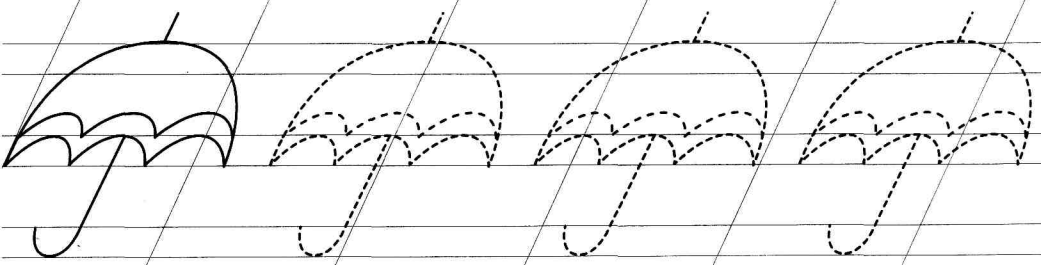
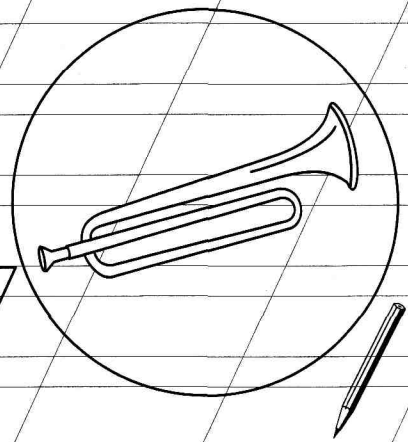
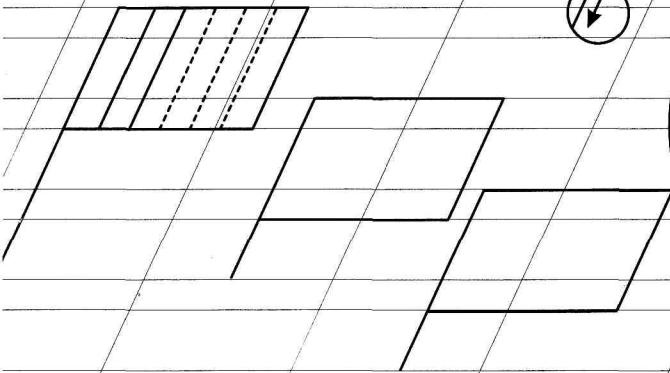



cccccccccc

cccccccccc

cccccccccc

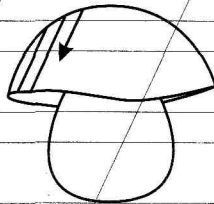
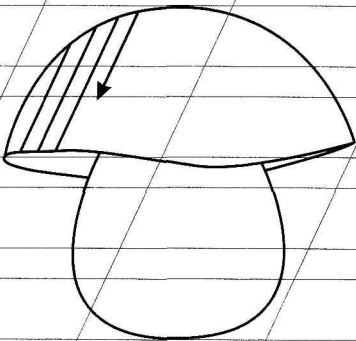
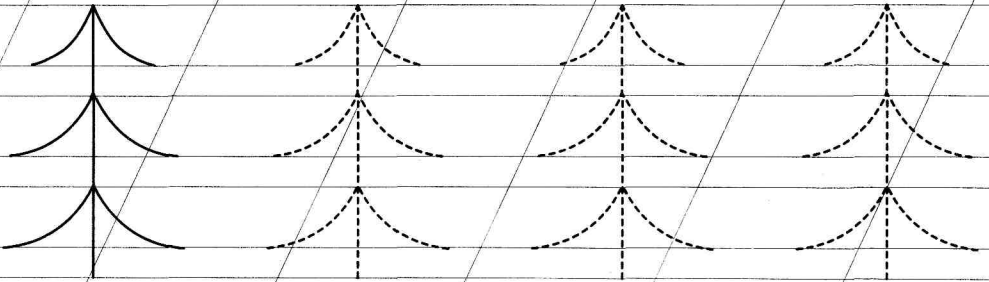

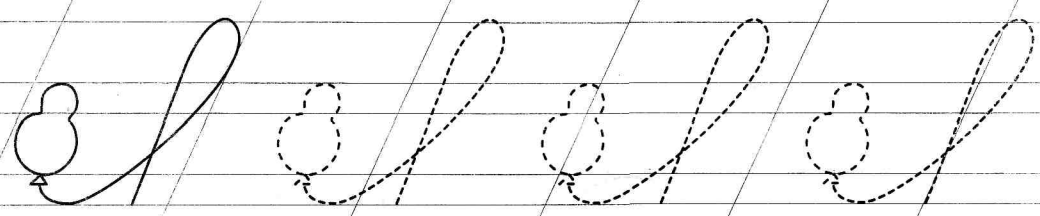
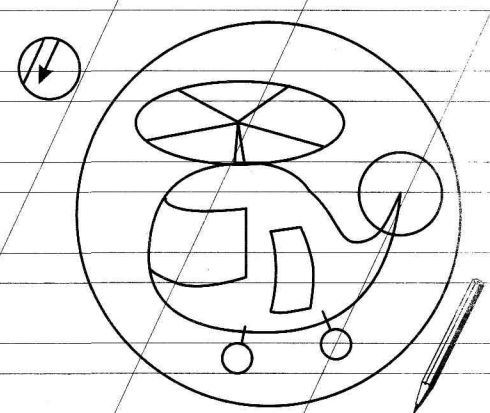
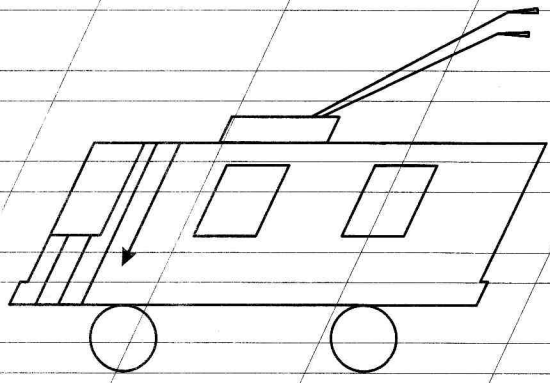

777777777777

7777777777

7L7L7L7L7L7L

7L7L7L7L7L



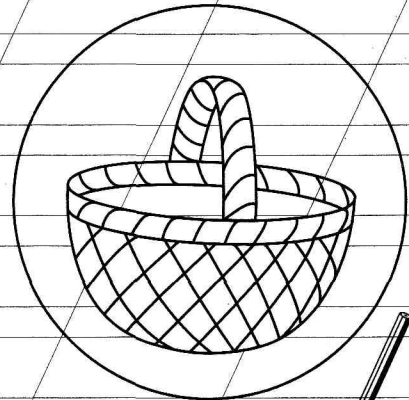
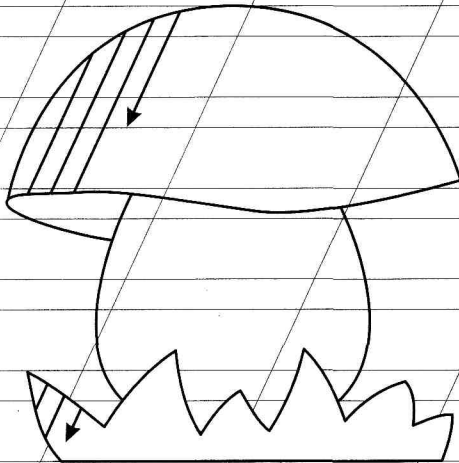
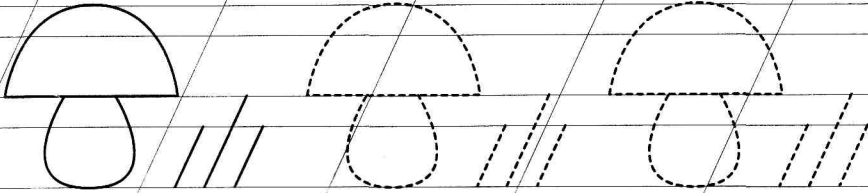
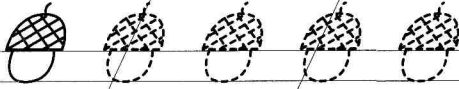
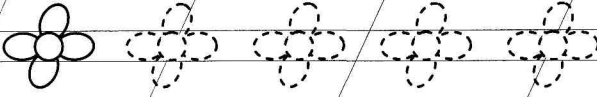

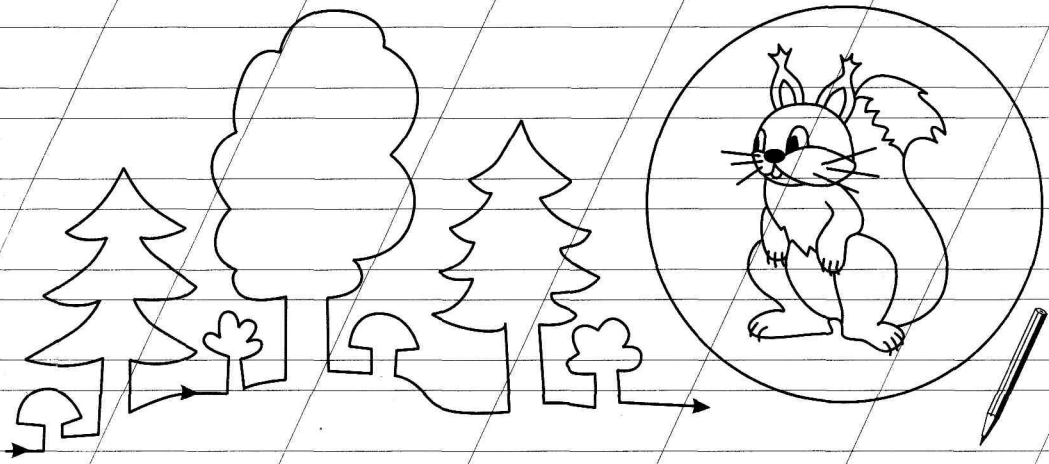

Handwriting practice for the cursive letter 'r'. The first row shows a solid cursive 'r' followed by four dashed cursive 'r's for tracing.

Handwriting practice for the cursive letter 'r'. This row contains seven small, solid cursive 'r's.

Handwriting practice for the cursive letter 'r'. This row contains seven small, solid cursive 'r's.

Handwriting practice for the cursive letter 'r'. This row contains six small, solid cursive 'r's.





o o o o o o o o o o

o o o o o o o o

o o o o o o

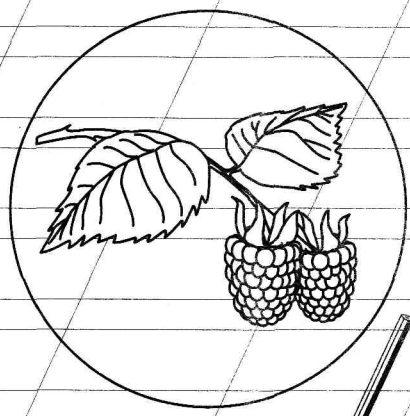
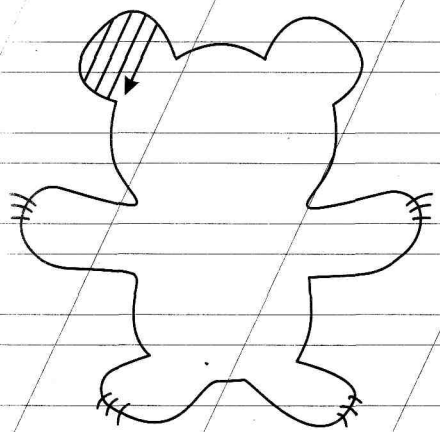
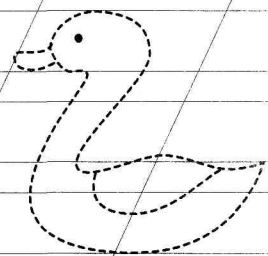
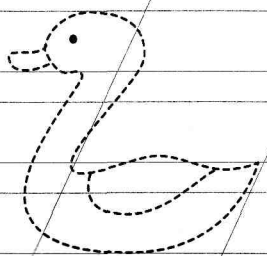
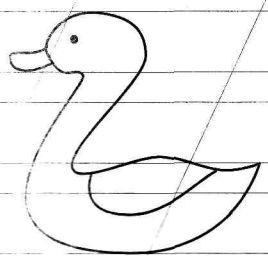

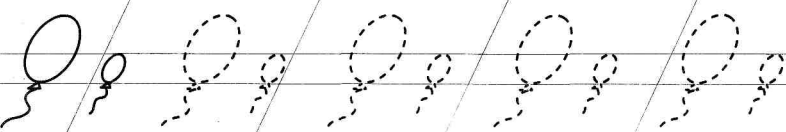
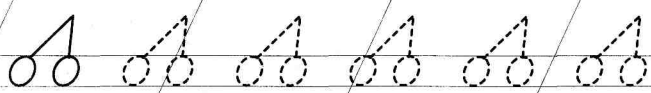
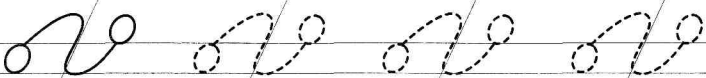
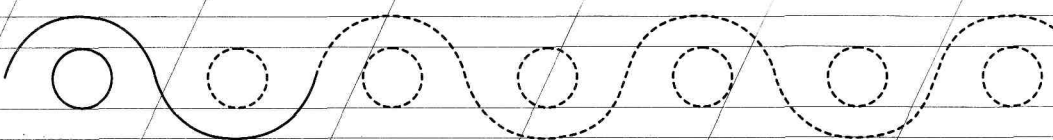
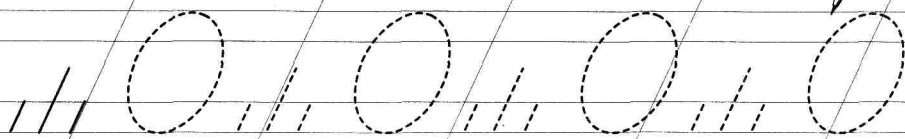
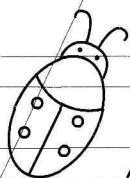
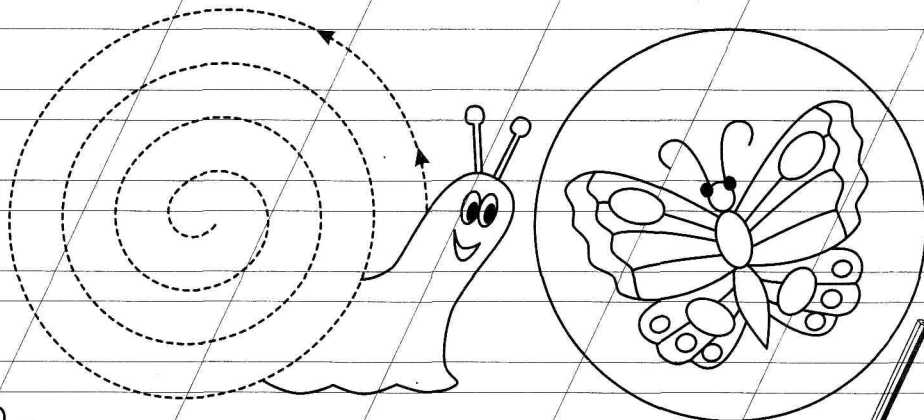

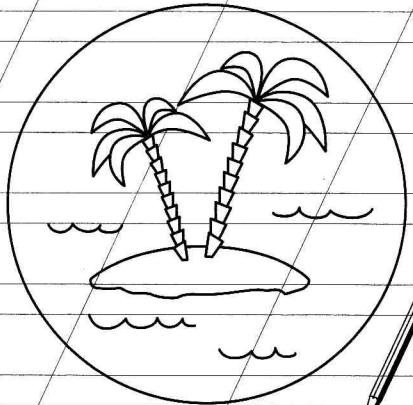
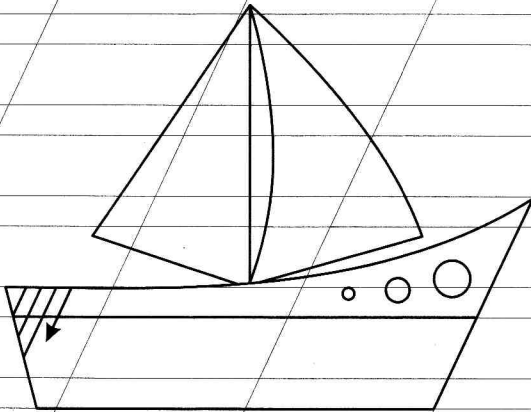
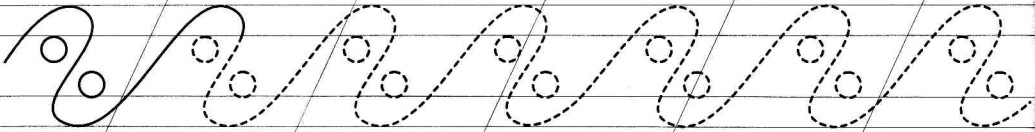
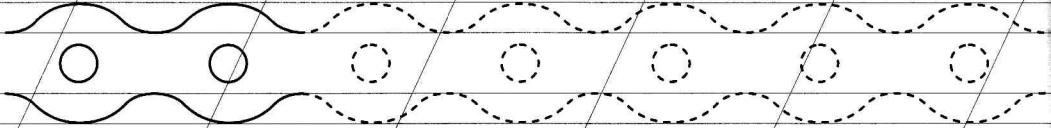
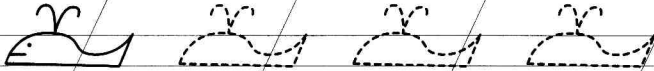
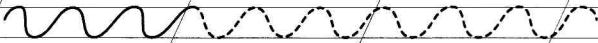
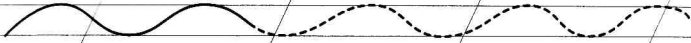

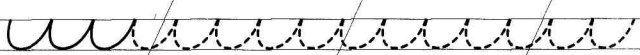
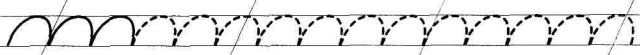
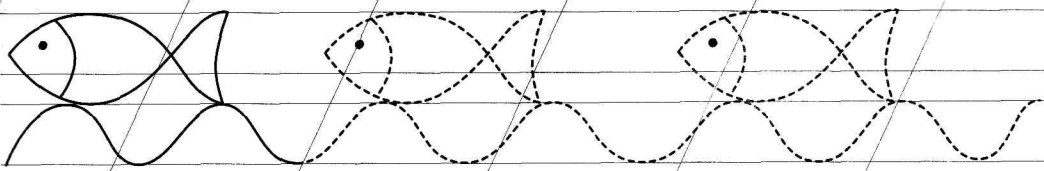
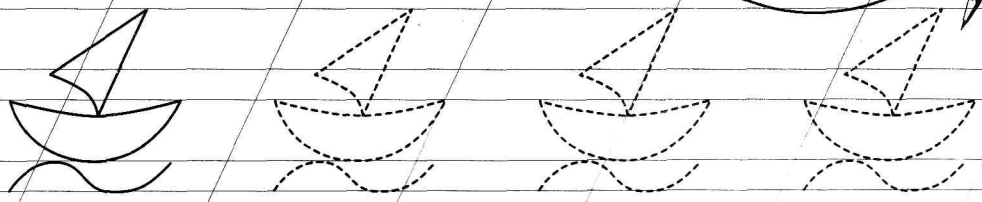
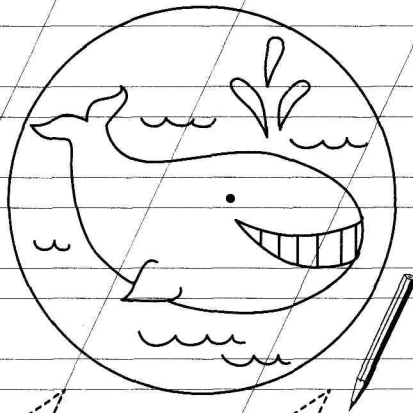



Handwritten cursive practice line consisting of a series of connected, rounded humps.

Handwritten cursive practice line consisting of a series of connected, rounded humps, similar to the one above but with more pronounced curves.



Large, dashed cursive letters for tracing, including 'r', 'y', 'l', 'l', 'y', 'l', 'l', 'y', 'l'.

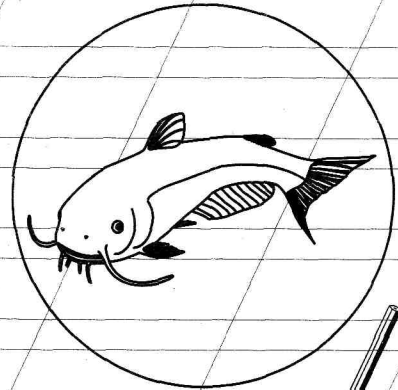
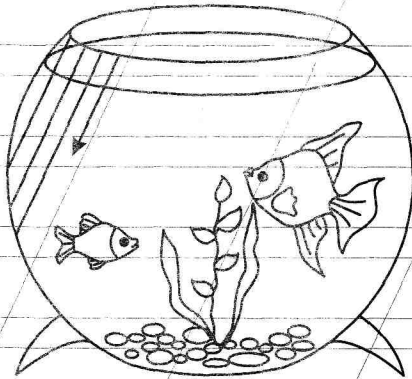

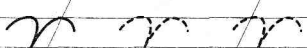
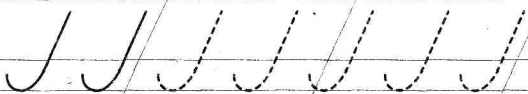
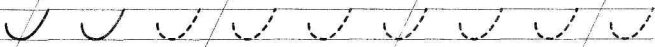
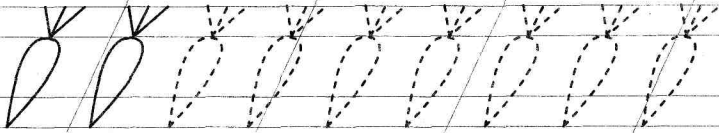
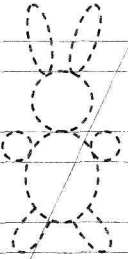
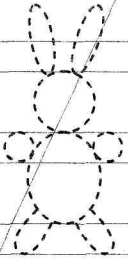
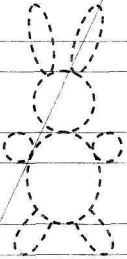
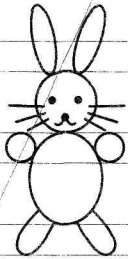
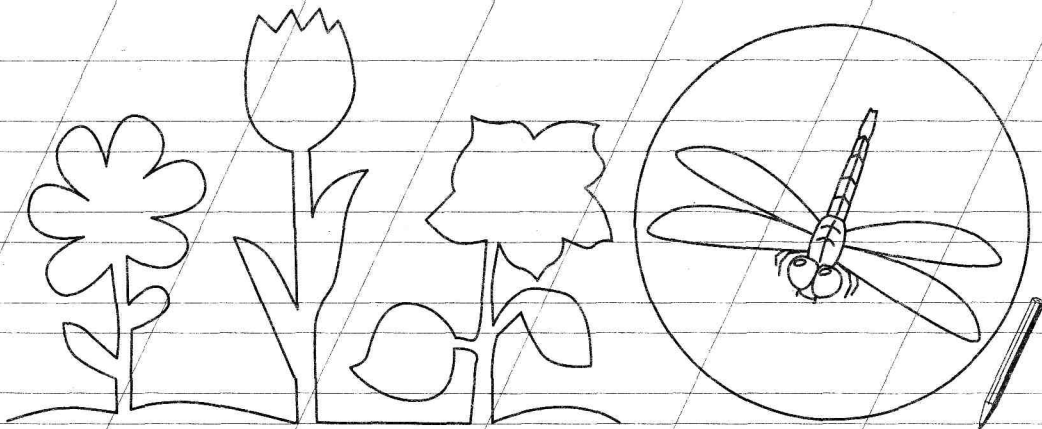

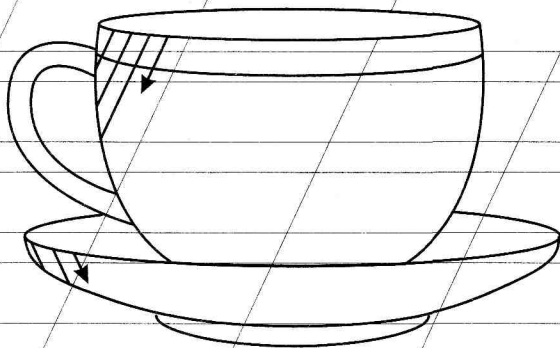
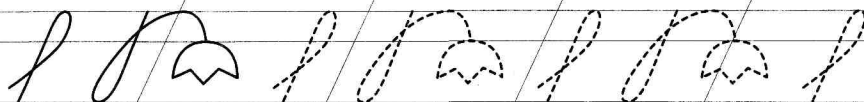
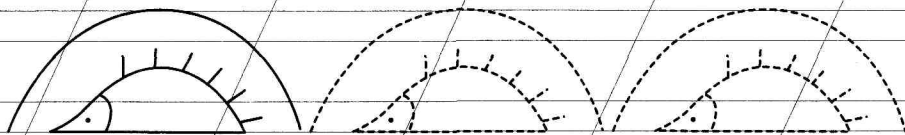
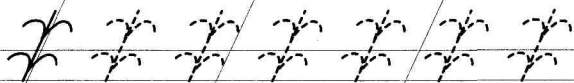

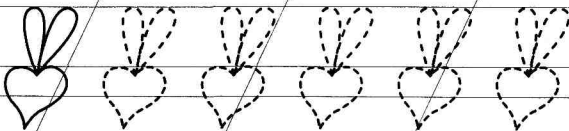
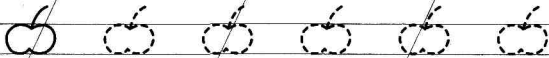
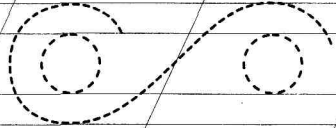
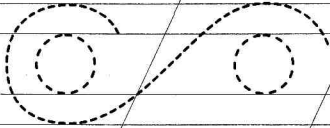
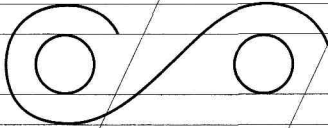
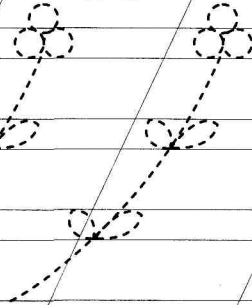
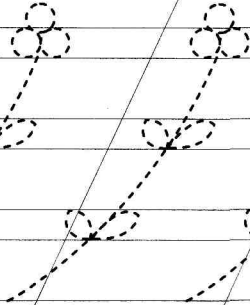
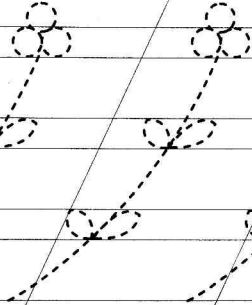
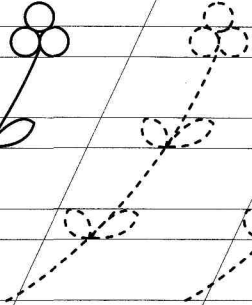
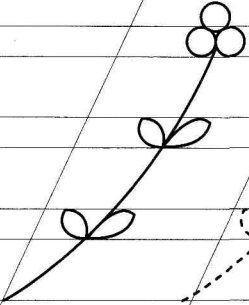
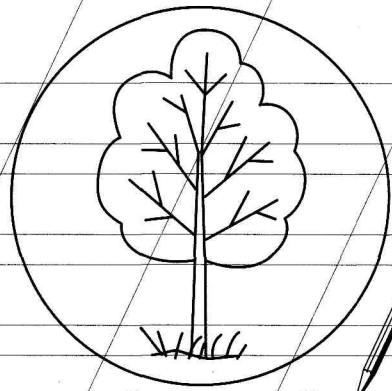
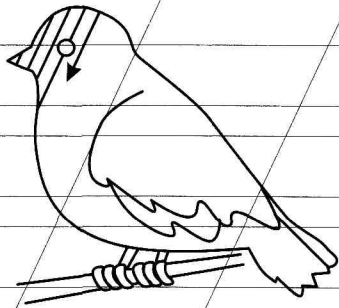



c c c c c c c c c c

o o o o o o o o o o

x x x x x x x x

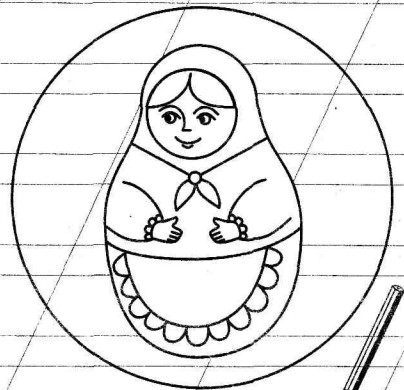
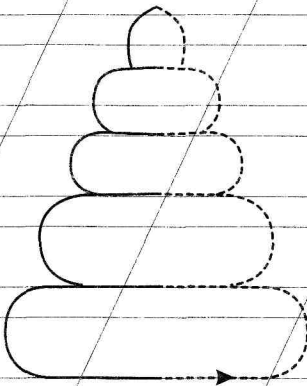
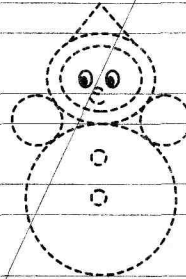
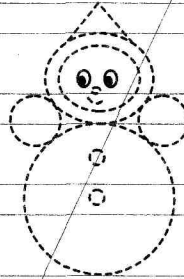
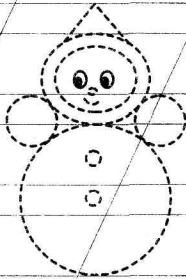
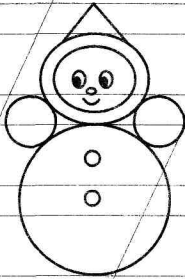

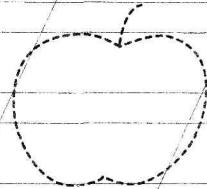
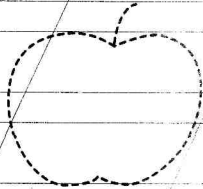
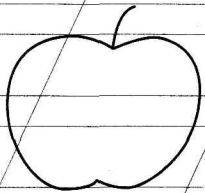
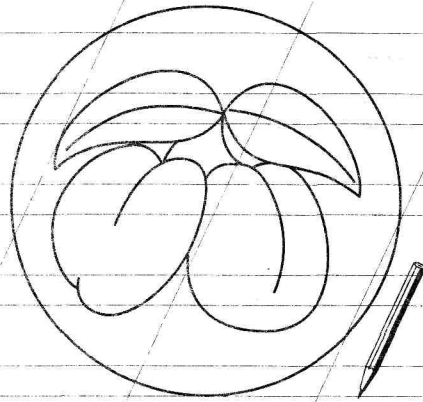
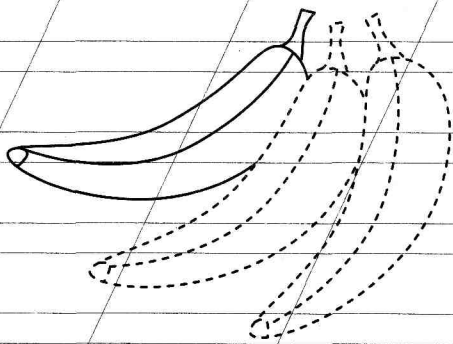

c c c c c c c c c c

o o o o o o o o o o

ccc CCC ccc CCC

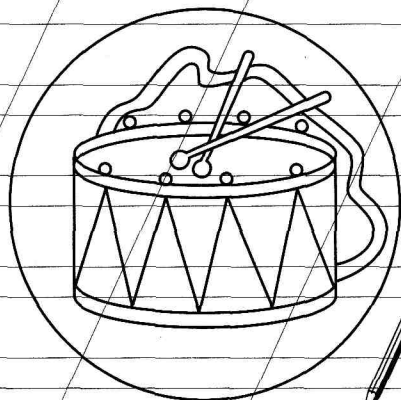
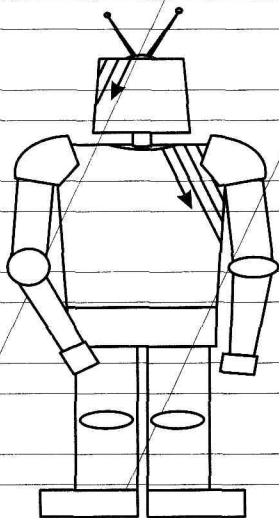
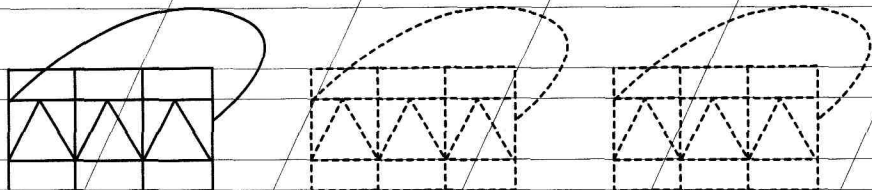
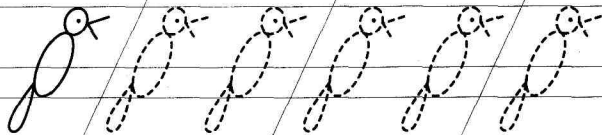
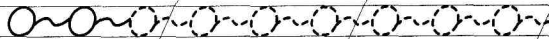

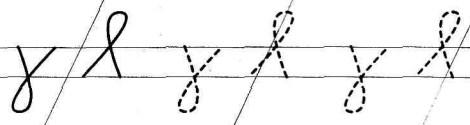
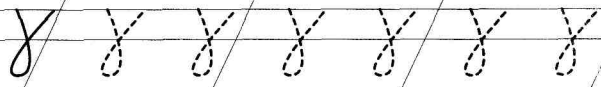
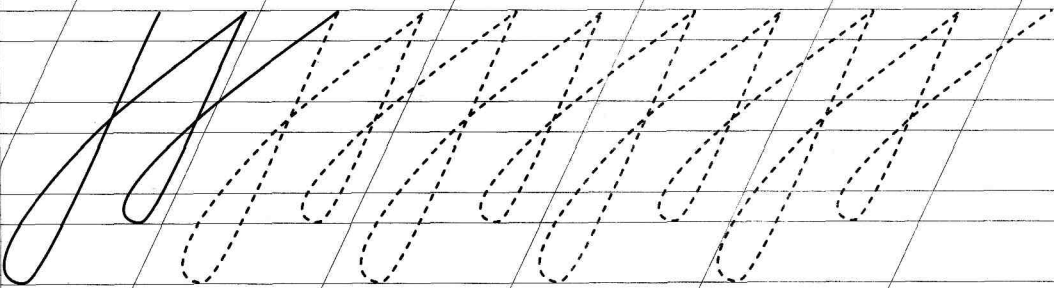
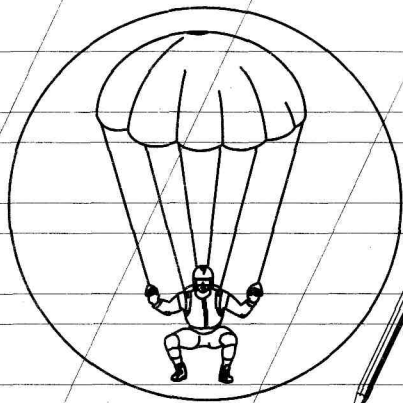
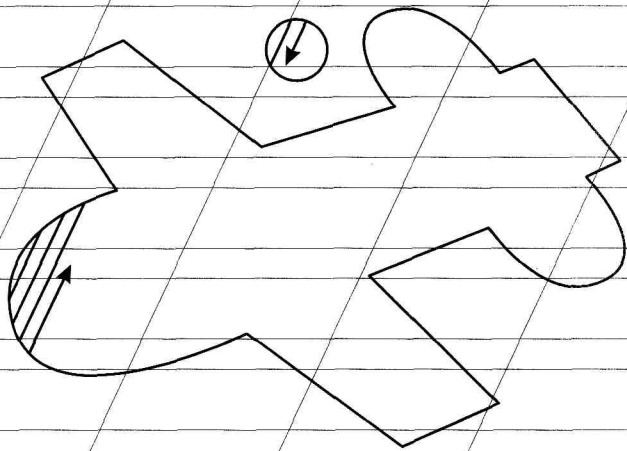



Handwriting practice row 1: A series of connected, slightly wavy horizontal lines.

Handwriting practice row 2: A series of connected, more pronounced wavy horizontal lines.

Handwriting practice row 3: A series of connected, rounded, wave-like horizontal lines.

Handwriting practice row 4: A series of connected, zig-zag horizontal lines with small circles at the peaks and valleys.

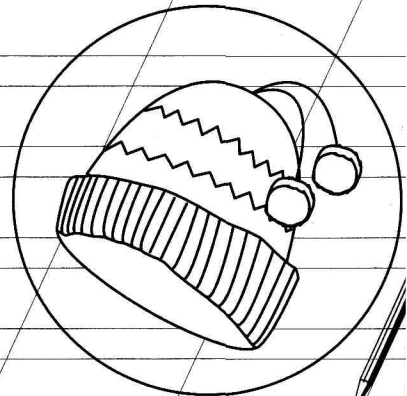
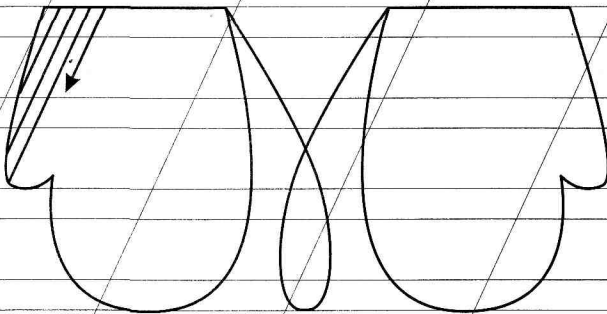

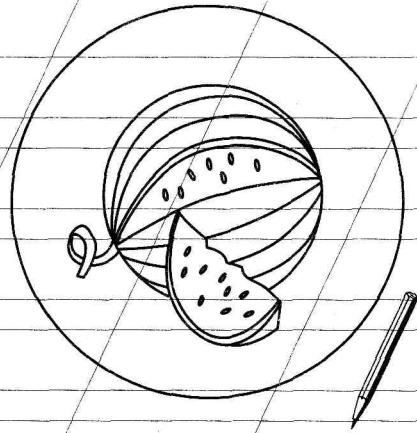
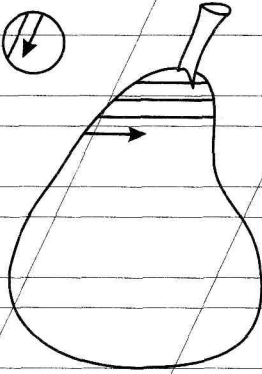
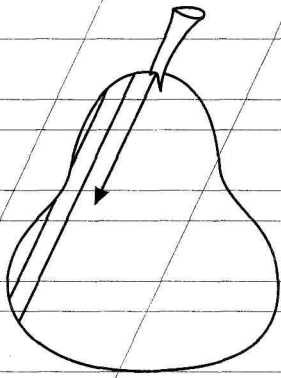

u u u

o o o o

l l l l l l l l

o o o o o o o o

l l o o l l o o l l o o





u u u u u u u u u u

m m m m m m m m m m

e e e e e e e e e e

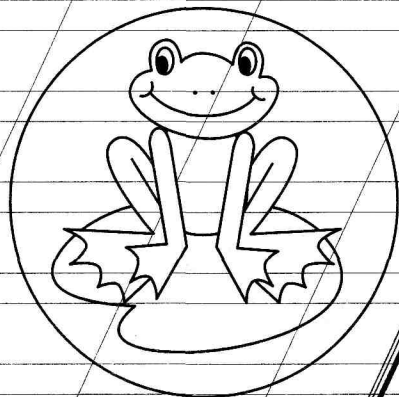
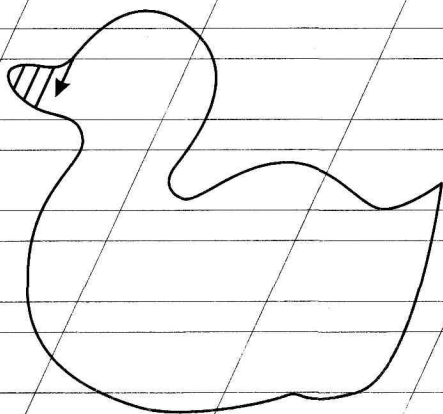
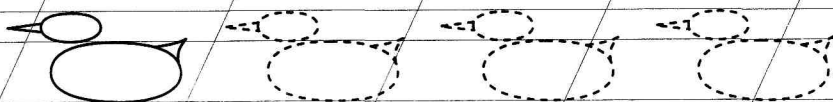

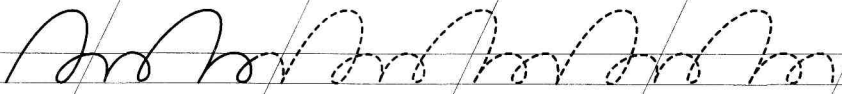
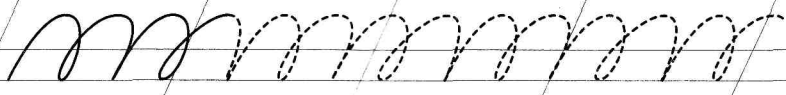
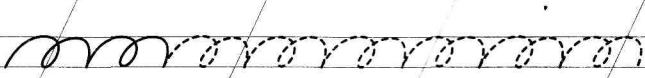
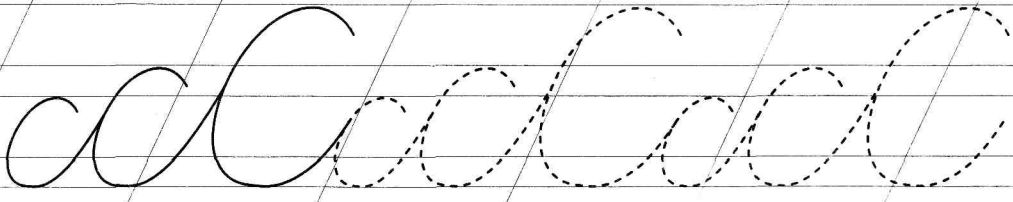
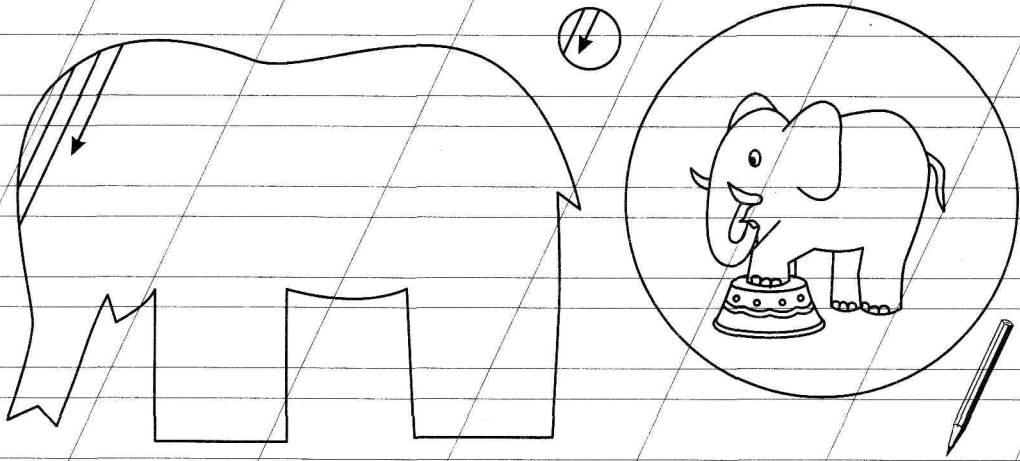



cccccccccccccccc

cccccccccc

cccccccc

